

You can download  
this catalog  
by scanning the  
QR code below.



Indoor / Outdoor  
Enclosure & AV Mount  
Solutions



**cletech**

Digital Signage Solutions

Güzelyurt Mahallesi 5760 Sokak No:22  
45030 Yunusemre / MANİSA / TÜRKİYE  
Phone: +90 236 234 10 38

[www.cletech.com.tr](http://www.cletech.com.tr) | [info@cletech.com.tr](mailto:info@cletech.com.tr) | [twitter/cletechds](https://twitter.com/cletechds) | [instagram/cletechds](https://www.instagram.com/cletechds)

**cletech**

For more detailed information  
and to access all products,  
visit our website.



[www.cletech.com.tr](http://www.cletech.com.tr)

## PAGE INDEX

10-11	About Cletech
12-13	<u>INDOOR ENCLOSURES</u>
14-15	Z01 Indoor Totem Enclosure
16-17	Z02 Indoor Mini-Totem Enclosure
18-19	Z04 Indoor Monitor Enclosure
20-21	ZX Indoor Totem Enclosure
22-23	ZL Indoor Totem Enclosure
24-25	B01 Indoor Totem Enclosure
26-27	BL Indoor Totem Enclosure
28-29	C01 Indoor Totem Enclosure
30-31	C05 Indoor Totem Enclosure
32-33	X02 Indoor Totem Enclosure
34-35	M1 Indoor Monitor Enclosure
36-37	M2 Indoor Desktop Monitor Stand
38-39	B04 Indoor Double-Sided Totem Enclosure
40-41	BX Indoor Double-Sided Totem Enclosure
42-43	C06 Indoor Double-Sided Totem Enclosure
44-45	X01 Indoor Double-Sided Totem Enclosure
46-47	XL Indoor Double-Sided Totem Enclosure
48-49	Z03 Indoor Kiosk Enclosure
50-51	ZS Indoor Self-Service Kiosk Enclosure
52-53	BS Indoor Self-Service Kiosk Enclosure
54-55	XK Indoor Kiosk Enclosure
56-57	XT Indoor Touch-Table Enclosure
58-59	DP3 Indoor Digital Podium
60-61	K Series Indoor Self-Service Kiosk Enclosure
62-63	<u>OUTDOOR ENCLOSURES</u>
64-65	M5 Outdoor Totem Enclosure
66-67	M5B Outdoor Totem Enclosure
68-69	M5C Outdoor Totem Enclosure
70-71	M5D Outdoor Double-Sided Totem Enclosure
72-73	F9 Outdoor Totem Enclosure
74-75	FX Outdoor Double-Sided Totem Enclosure
76-77	RS Outdoor Totem Enclosure
78-79	RD Outdoor Double-Sided Totem Enclosure
80-81	XR Outdoor Totem Enclosure for Full Outdoor Monitors
82-83	WX Outdoor Double-Sided Totem Enclosure for Full Outdoor Monitors
84-85	T1 Outdoor Totem Enclosure for Full Outdoor Monitors
86-87	DT1 Outdoor Totem Enclosure for Single Full Outdoor Monitors
88-89	DT2 Outdoor Totem Enclosure for Double Full Outdoor Monitors
90-91	DT3 Outdoor Totem Enclosure for Triple Full Outdoor Monitors
92-93	K Series Outdoor Self-Service Kiosk Enclosure
94-95	L1 Outdoor Totem Enclosure for LED Panels
96-97	<u>AV MOUNTS</u>
98-99	Floor Stands ST1 Series
100-101	Trolleys ST2 Series
102-103	Trolleys ST3 Series
104-105	Rotational Stand
106-107	Motorized Stands
108-109	Fix Floor Mounts FX1 & FX2 Series
110-113	Multi Display Mounts
114-117	Components & Accessories





# Indoor Single Sided Enclosures

Z01

PAGE 14-15



Z02

PAGE 16-17



C05

PAGE 30-31



B01

PAGE 24-25



ZL

PAGE 22-23



BL

PAGE 26-27



C01

PAGE 28-29



X02

PAGE 32-33



Z04

PAGE 18-19

ZX

PAGE 20-21



M1

PAGE 34-35



M2

PAGE 36-37





# Indoor Double Sided Enclosures

B04

PAGE 38-39



BX

PAGE 40-41



XL

PAGE 46-47



C06

PAGE 42-43



X01

PAGE 44-45



# Indoor Kiosk Enclosures

Self Order | Info | Touch Table | Podium

Z03

PAGE 48-49



XK

PAGE 54-55



XT

PAGE 56-57



NEW  
K Series

PAGE 60-61



ZS

PAGE 50-51



BS

PAGE 52-53



DP3

PAGE 58-59







# Outdoor Enclosures

Totem | Self Order | Info | Drive-Thru

M5

PAGE 64-65



RS

PAGE 76-77



NEW

DT1

PAGE 86-87



NEW

L1

PAGE 94-95



M5B

PAGE 66-67



RD

PAGE 78-79



NEW

DT2

PAGE 88-89



NEW

K Series Outdoor

PAGE 92-93



M5C

PAGE 68-69



XR

PAGE 80-81



M5D

PAGE 70-71



T1

PAGE 84-85



NEW

DT3

PAGE 90-91

F9

PAGE 72-73



WX

PAGE 82-83



FX

PAGE 74-75







# AV Mounting Solutions

Floor Stands  
ST1 Series

PAGE 98-98



Motorized  
Stands

PAGE 106-107



Trolleys  
ST2 Series

PAGE 100-101



Fix Floor Mounts  
FX1 & FX2 Series

PAGE 108-109

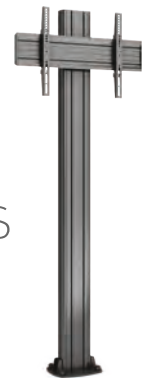

Trolleys  
ST3 Series

PAGE 102-103



Multi Display  
Mounts

PAGE 110-113



Rotational  
Stands

PAGE 104-105



Components  
Accessories

PAGE 114-117





# INNOVATIVE AND CREATIVE SOLUTIONS

## Who we are?

Cletech, a registered trademark of HİRAŞ LTD., was established in 1994. Digital Signage Projects and Digital Signage Enclosures are being served to end users and to integrators by Cletech that has been manufacturing for 30 years in Manisa where is one of the largest industrial cities of Turkey.

As Cletech, we follow all production processes in our factory. Quality is under control with metal processing, forming, dyehouse, electronic and mechanical assembly lines. We combine innovative solutions with our products continuously at the time technology is developing very fast. In addition to our standard products, we can offer solutions to special projects. We also have expertise in fully customizable products with custom product designs, color and material variety, extra hardware options. We transfer our experiences that have gained through the global projects carried out to new projects. We determine our sales strategies especially with high product quality and affordable price policy.

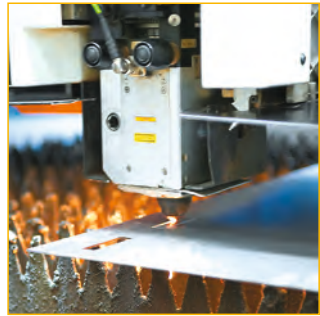

Metal Processing



Metal Forming



Welded Manufacturing



Paint Coating



Mechanical Assembly



Electronical Assembly



Quality Control



Packaging

**cletech**



# Indoor Products





# Z01 Indoor Totem Enclosure

Portrait / Single Sided  
32" | 43" | 49" | 50" | 55" | 65" | 75"



Show this product on the website



## Key Features

- High Quality Finishes
- Easy Access for Maintenance
- 4mm Ceramic Painted Tempered Glass
- Available for Floor Mounts
- Easy Monitor-TV Mounting
- Aluminum Main Chasis

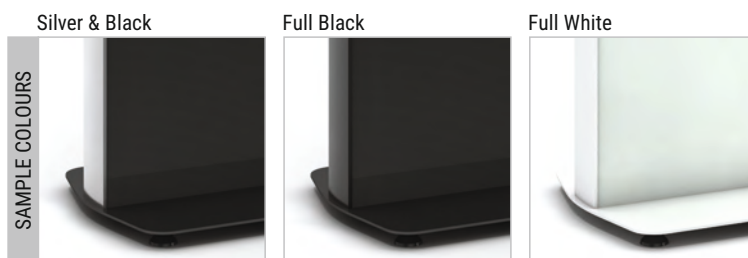

## Main Features

● Included ● Optional ● On Project ● Not Available

Custom Color	Client Logo	Floor Mounts	Base Wheels	Base Feet	Tempered Glass	Lockable Cover	PDU 3 x Socket	Fans for Ventilation	Touch Screen

MONITOR		ENCLOSURE				PACKAGE	
Display (inch)	Mountable Max. Monitor Dimension	Dimension without Flange (WxHxD)	Dimension with Flange (WxHxD)	Weight (kg)	Viewing Area (WxH)	Dimension (WxHxD)	Weight (kg)
32"	435x740x55 mm	576x1839x100 mm	596x1839x400 mm	61	393x698 mm	655x1930x150 mm	64
43"	570x980x55 mm	710x1939x100 mm	730x1939x450 mm	76	529x941 mm	790x2030x150 mm	79
49"	645x1115x55 mm	784x1939x100 mm	804x1939x450 mm	84	604x1074 mm	860x2030x150 mm	87
50"	655x1135x55 mm	797x1939x100 mm	816x1939x450 mm	85	616x1096 mm	870x2030x150 mm	88
55"	720x1250x55 mm	860x2044x100 mm	880x2044x500 mm	100	680x1210 mm	945x2130x150 mm	103
65"	845x1470x55 mm	984x2144x100 mm	1004x2144x550 mm	121	804x1428 mm	1065x2230x150 mm	124
75"	970x1690x55 mm	1112x2244x100 mm	1200x2244x600 mm	156	928x1650 mm	1200x2330x150 mm	159

\* Multiple product package sizes may differ from the information written above. Please get information when you order.



# Z02 Indoor Mini-Totem Enclosure

Portrait / Single Sided  
43" | 49" | 50" | 55"



## Key Features

- High Quality Finishes
- Easy Access for Maintenance
- 4mm Ceramic Painted Tempered Glass
- Standard Base Wheels
- Easy Monitor-TV Mounting
- Aluminum Main Chasis

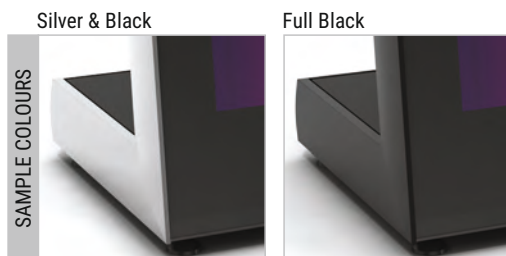

## Main Features

● Included ● Optional ● On Project ● Not Available

Custom Color	Client Logo	Floor Mounts	Base Wheels	Base Feet	Tempered Glass	Lockable Cover	PDU 3 x Socket	Fans for Ventilation	Touch Screen

MONITOR		ENCLOSURE				PACKAGE	
Display (inch)	Mountable Max. Monitor Dimension	Dimension without Flange (WxHxD)	Dimension with Stand (WxHxD)	Weight (kg)	Viewing Area (WxH)	Dimension (WxHxD)	Weight (kg)
43"	570x980x55 mm	710x1293x100 mm	710x1293x505 mm	55	529x941 mm	790x1470x580 mm	60
49"	645x1115x55 mm	784x1362x100 mm	784x1362x505 mm	58	604x1074 mm	870x1560x580 mm	63
50"	655x1135x55 mm	784x1362x100 mm	784x1362x505 mm	58	616x1096 mm	870x1560x580 mm	63
55"	720x1250x55 mm	861x1474x100 mm	861x1474x505 mm	68	680x1210 mm	945x1660x580 mm	73

\* Multiple product package sizes may differ from the information written above. Please get information when you order.



# Z04 Indoor Monitor Enclosure

Portrait & Landscape / Single Sided  
32" | 43" | 49" | 50" | 55" | 65" | 75"



Show this product on the website

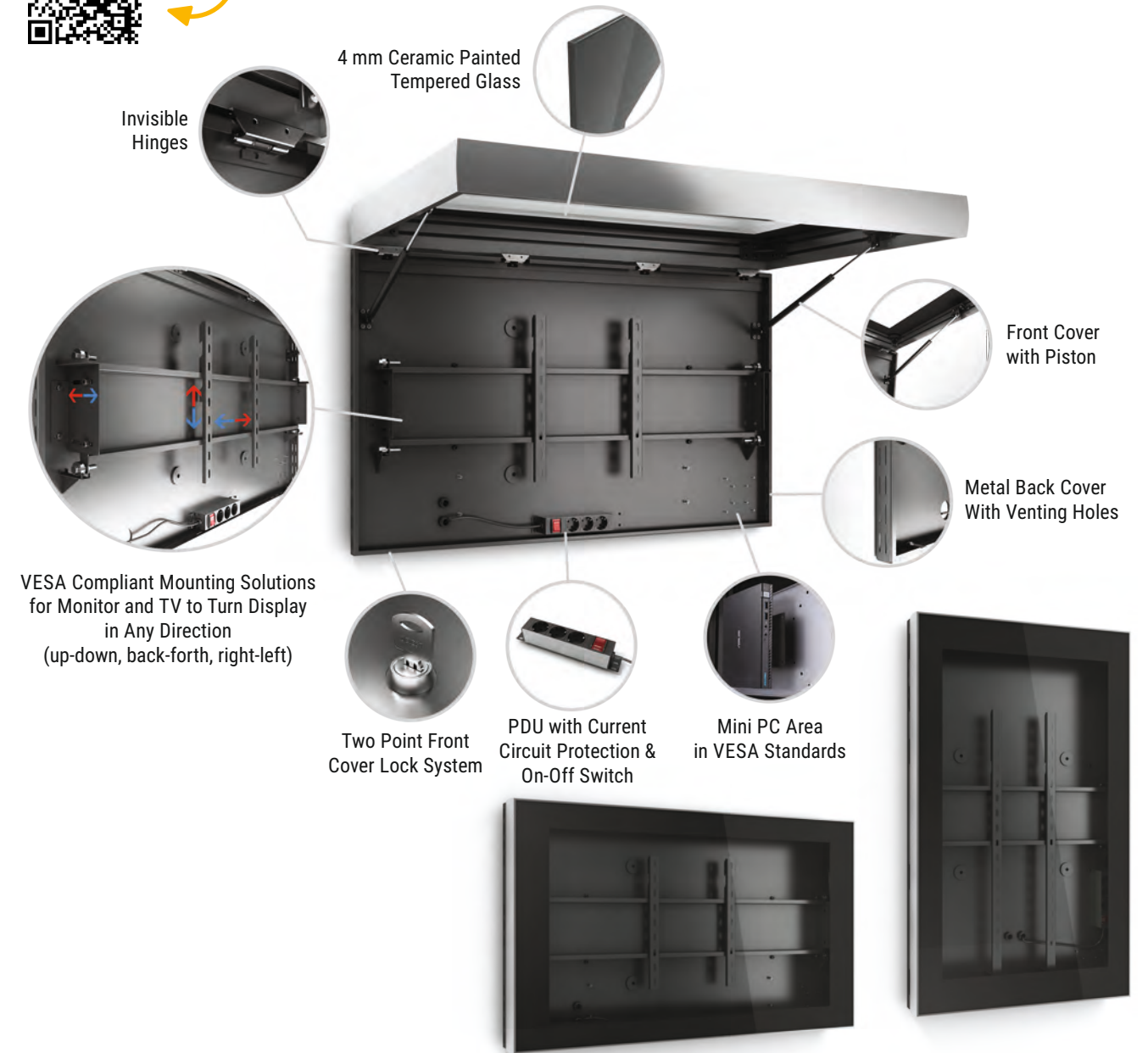

## Key Features

- High Quality Finishes
- Easy Access for Maintenance
- 4mm Ceramic Painted Tempered Glass
- Available for Wall & Ceiling Mounts
- Easy Monitor-TV Mounting
- Aluminum Front Cover Frame



## Main Features

● Included ● Optional ● On Project ● Not Available

Custom Color	Client Logo	Ceiling Mounts	Wall Mount	Base Feet	Tempered Glass	Lockable Cover	PDU 3 x Socket	Fans for Ventilation	Touch Screen

MONITOR		ENCLOSURE			PACKAGE	
Display (inch)	Mountable Max. Monitor Dimension	Dimension (WxHxD)	Weight (kg)	Viewing Area (WxH)	Dimension (WxHxD)	Weight (kg)
32"	435x740x100 mm	929x573x138 mm	33	393x698 mm	990x630x200 mm	36
43"	570x980x100 mm	1172x709x138 mm	62	529x941 mm	1230x770x200 mm	66
49"	645x1115x100 mm	1307x784x138 mm	77	604x1074 mm	1400x870x200 mm	72
50"	655x1135x100 mm	1329x796x138 mm	78	616x1096 mm	1400x870x200 mm	73
55"	720x1250x100 mm	1443x861x138 mm	94	680x1210 mm	1510x920x200 mm	99
65"	845x1470x100 mm	1662x984x138 mm	126	804x1428 mm	1720x1050x200 mm	130
75"	970x1690x100 mm	1884x1108x138 mm	164	928x1650 mm	1980x1150x200 mm	170

\* Multiple product package sizes may differ from the information written above. Please get information when you order.



# ZX Indoor Totem Enclosure

Portrait / Single Sided  
32" | 43" | 49" | 50" | 55" | 65" | 75"

cletech



The Cletech ZX Totem Enclosure is compatible with a wide range of professional monitors from various brands. It provides reliable protection for indoor environments, standing out with its elegant design and high-quality materials. Combining durability with aesthetic appeal, it offers users an exceptional experience.

## Key Features

- 4 mm Ceramic Painted Tempered Glass
- Aluminum Main Chasis
- VESA Standard Mounting Holes



Show this product on the website

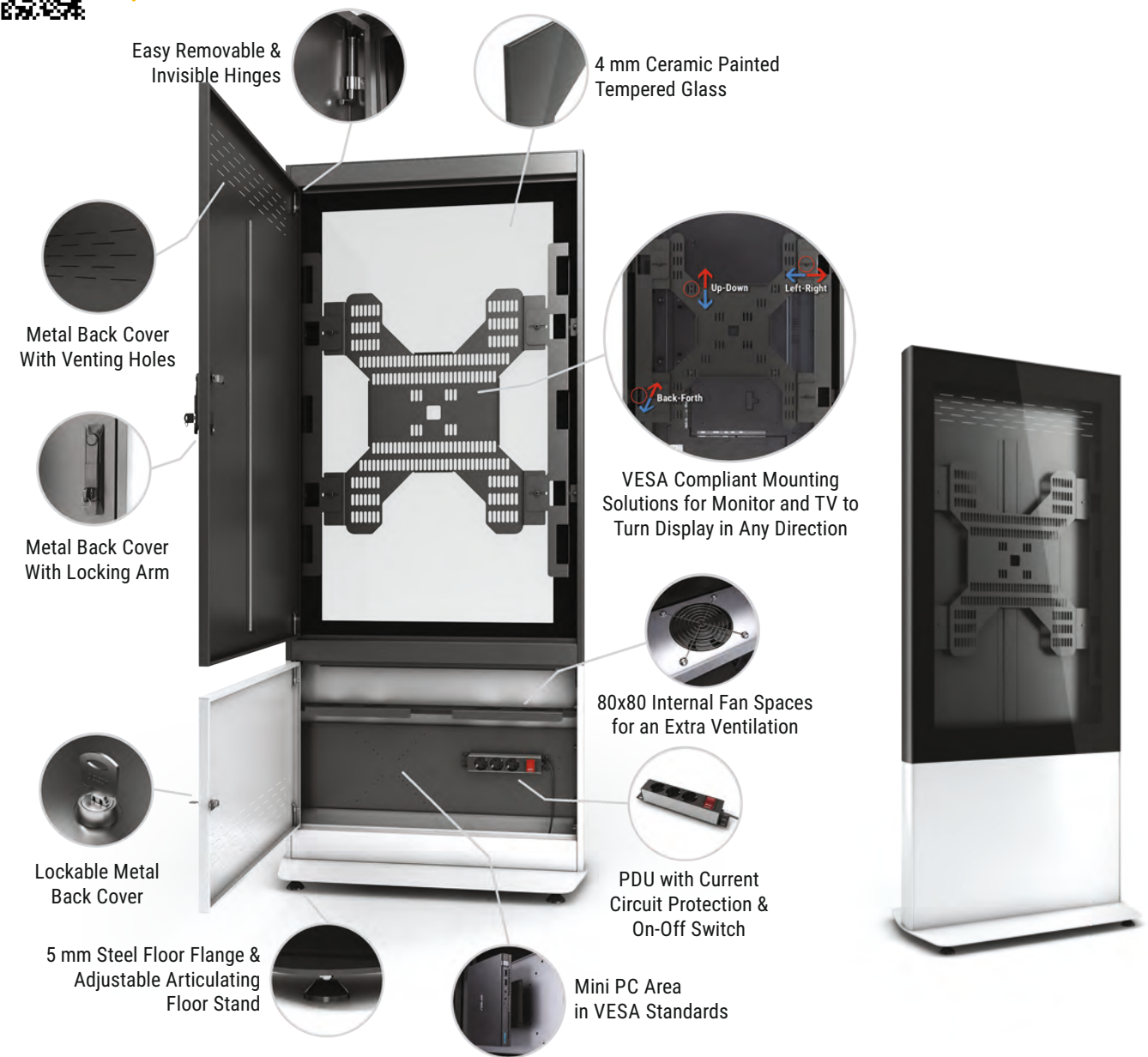

## Main Features

● Included ● Optional ● On Project ● Not Available

Custom Color	Client Logo	Floor Mounts	Base Wheels	Base Feet	Tempered Glass	Lockable Cover	PDU 3 x Socket	Fans for Ventilation	Touch Screen

MONITOR		ENCLOSURE				PACKAGE	
Display (inch)	Mountable Max. Monitor Dimension	Dimension without Flange (WxHxD)	Dimension with Flange (WxHxD)	Weight (kg)	Viewing Area (WxH)	Dimension (WxHxD)	Weight (kg)
32"	435x740x55 mm	576x1839x100 mm	596x1839x400 mm	61	393x698 mm	655x1930x150 mm	64
43"	570x980x55 mm	710x1939x100 mm	730x1939x450 mm	76	529x941 mm	790x2030x150 mm	79
49"	645x1115x55 mm	784x1939x100 mm	804x1939x450 mm	84	604x1074 mm	860x2030x150 mm	87
50"	655x1135x55 mm	797x1939x100 mm	816x1939x450 mm	85	616x1096 mm	870x2030x150 mm	88
55"	720x1250x55 mm	860x2044x100 mm	880x2044x500 mm	100	680x1210 mm	945x2130x150 mm	103
65"	845x1470x55 mm	984x2144x100 mm	1004x2144x550 mm	121	804x1428 mm	1065x2230x150 mm	124
75"	970x1690x55 mm	1112x2244x100 mm	1200x2244x600 mm	156	928x1650 mm	1200x2330x150 mm	159

\* Multiple product package sizes may differ from the information written above. Please get information when you order.





### Key Features

- High Quality Finishes
- Easy Access for Maintenance
- 4mm Ceramic Painted Tempered Glass
- Available for Floor Mounts
- Easy Monitor-TV Mounting
- Aluminum Main Chasis

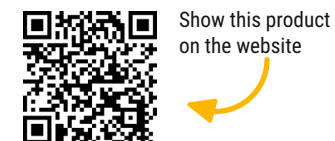
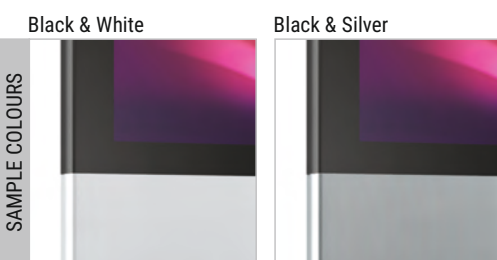

### Main Features

● Included ● Optional ● On Project ● Not Available

Custom Color	Client Logo	Floor Mounts	Base Wheels	Base Feet	Tempered Glass	Lockable Cover	PDU 3 x Socket	Fans for Ventilation	Touch Screen

MONITOR		ENCLOSURE				PACKAGE	
Display (inch)	Mountable Max. Monitor Dimension	Dimension without Flange (WxHxD)	Dimension with Flange (WxHxD)	Weight (kg)	Viewing Area (WxH)	Dimension (WxHxD)	Weight (kg)
32"	435x740x55 mm	929x1844x100 mm	949x1844x450 mm	72	698x393 mm	980x1900x160 mm	75
43"	570x980x55 mm	1172x1844x100 mm	1192x1844x450 mm	88	941x529 mm	1210x1900x160 mm	92
49"	645x1115x55 mm	1327x1844x100 mm	1347x1844x450 mm	103	1074x604 mm	1380x1900x160 mm	107
50"	655x1135x55 mm	1329x1844x100 mm	1349x1844x450 mm	104	1096x616 mm	1380x1900x160 mm	108
55"	720x1250x55 mm	1443x1900x100 mm	1463x1900x450 mm	122	680x1210 mm	1480x1950x160 mm	128

\* Multiple product package sizes may differ from the information written above. Please get information when you order.



# B01 Indoor Totem Enclosure

Portrait / Single Sided  
32" | 43" | 49" | 50" | 55" | 65" | 75"



Show this product on the website



## Key Features

- High Quality Finishes
- Easy Access for Maintenance
- Available for Floor Mounts
- Easy Monitor-TV Mounting
- Lockable Front & Back Covers



Grey & Anthracite      Full Black



## Main Features

● Included    ● Optional    ● On Project    ● Not Available

Custom Color	Client Logo	Floor Mounts	Base Wheels	Base Feet	Tempered Glass	Lockable Cover	PDU 3 x Socket	Fans for Ventilation	Touch Screen

MONITOR		ENCLOSURE				PACKAGE	
Display (inch)	Mountable Max. Monitor Dimension	Dimension without Flange (WxHxD)	Dimension with Flange (WxHxD)	Weight (kg)	Viewing Area (WxH)	Dimension (WxHxD)	Weight (kg)
32"	435x740x70 mm	579x1877x120 mm	579x1877x450 mm	52	393x698 mm	1950x640x160 mm	56
43"	570x980x70 mm	715x1977x120 mm	715x1977x500 mm	62	529x941 mm	2050x760x160 mm	66
49"	645x1115x70 mm	790x1977x120 mm	790x1977x500 mm	64	604x1074 mm	2050x840x160 mm	70
50"	655x1135x70 mm	796x1977x120 mm	796x1977x500 mm	64	616x1096 mm	2050x840x160 mm	70
55"	720x1250x70 mm	860x1977x120 mm	860x1977x500 mm	68	680x1210 mm	2050x900x160 mm	72
65"	845x1470x70 mm	983x2177x120 mm	983x2177x550 mm	73	804x1428 mm	2250x1040x160 mm	78
75"	970x1690x70 mm	1112x2225x120 mm	1112x2225x600 mm	82	928x1650 mm	2250x1160x160 mm	87

\* Multiple product package sizes may differ from the information written above. Please get information when you order.





**Key Features**

- High Quality Finishes
- Easy Access for Maintenance
- Available for Floor Mounts
- Easy Monitor-TV Mounting
- Lockable Front & Back Covers



Show this product on the website

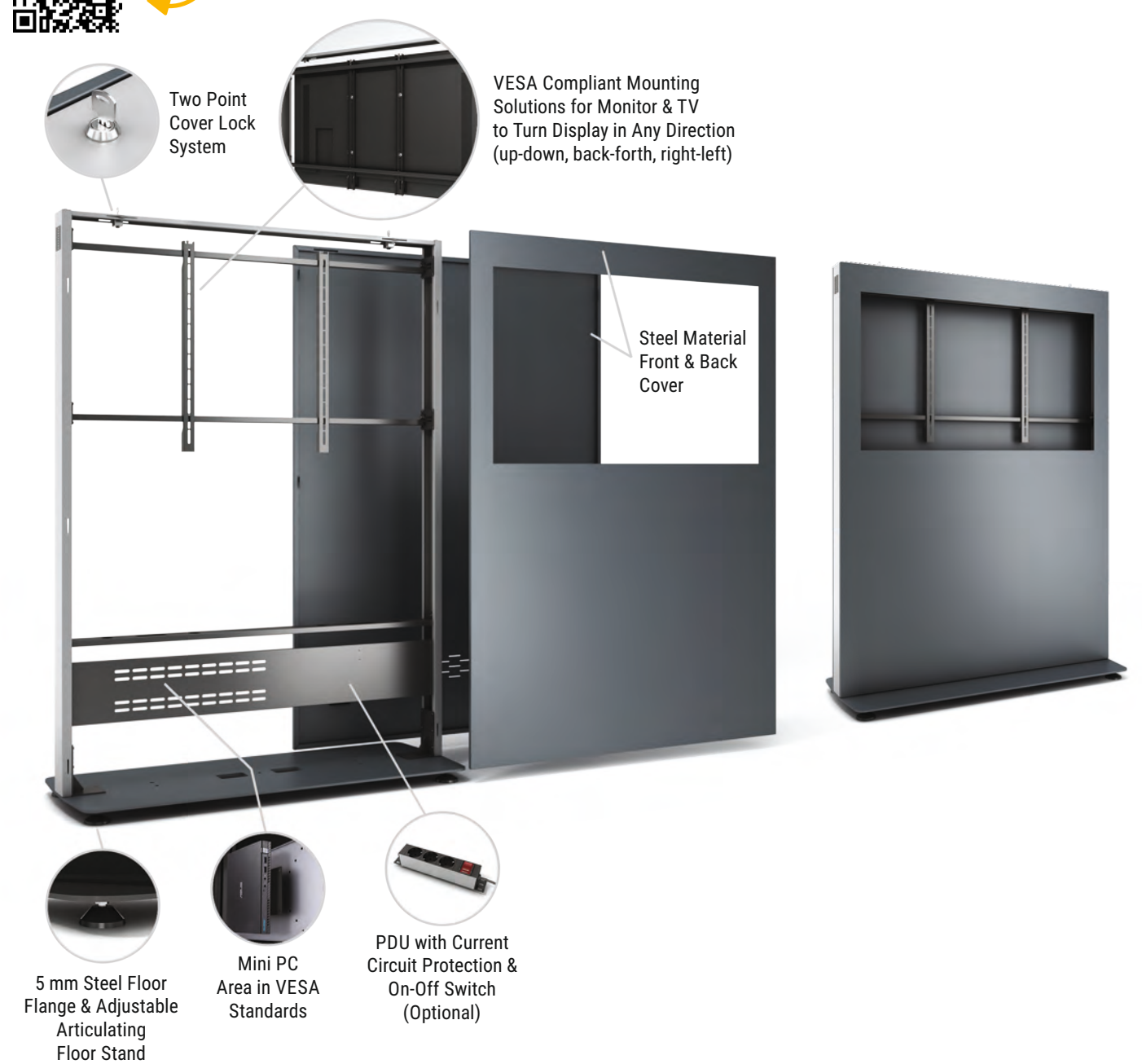

**Main Features**

● Included ● Optional ● On Project ● Not Available

Custom Color	Client Logo	Floor Mounts	Base Wheels	Base Feet	Tempered Glass	Lockable Cover	PDU 3 x Socket	Fans for Ventilation	Touch Screen

MONITOR		ENCLOSURE				PACKAGE	
Display (inch)	Mountable Max. Monitor Dimension	Dimension without Flange (WxHxD)	Dimension with Flange (WxHxD)	Weight (kg)	Viewing Area (WxH)	Dimension (WxHxD)	Weight (kg)
32"	740x740x70 mm	890x1844x120 mm	890x1844x500 mm	48	698x393 mm	950x1900x200 mm	50
43"	980x570x70 mm	1126x1844x120 mm	1126x1844x500 mm	66	941x529 mm	1180x1900x200 mm	69
49"	1115x645x70 mm	1261x1844x120 mm	1261x1844x500 mm	70	1074x604 mm	1330x1900x200 mm	74
50"	1135x655x70 mm	1276x1844x120 mm	1276x1844x500 mm	70	1096x616 mm	1330x1900x200 mm	74
55"	1250x720x70 mm	1390x1900x120 mm	1390x1900x500 mm	76	1210x680 mm	1440x1950x200 mm	80

\* Multiple product package sizes may differ from the information written above. Please get information when you order.



# C01 Slim Design Indoor Totem Enclosure

Portrait / Single Sided  
32" | 43" | 49" | 50" | 55" | 65" | 75"



Show this product on the website

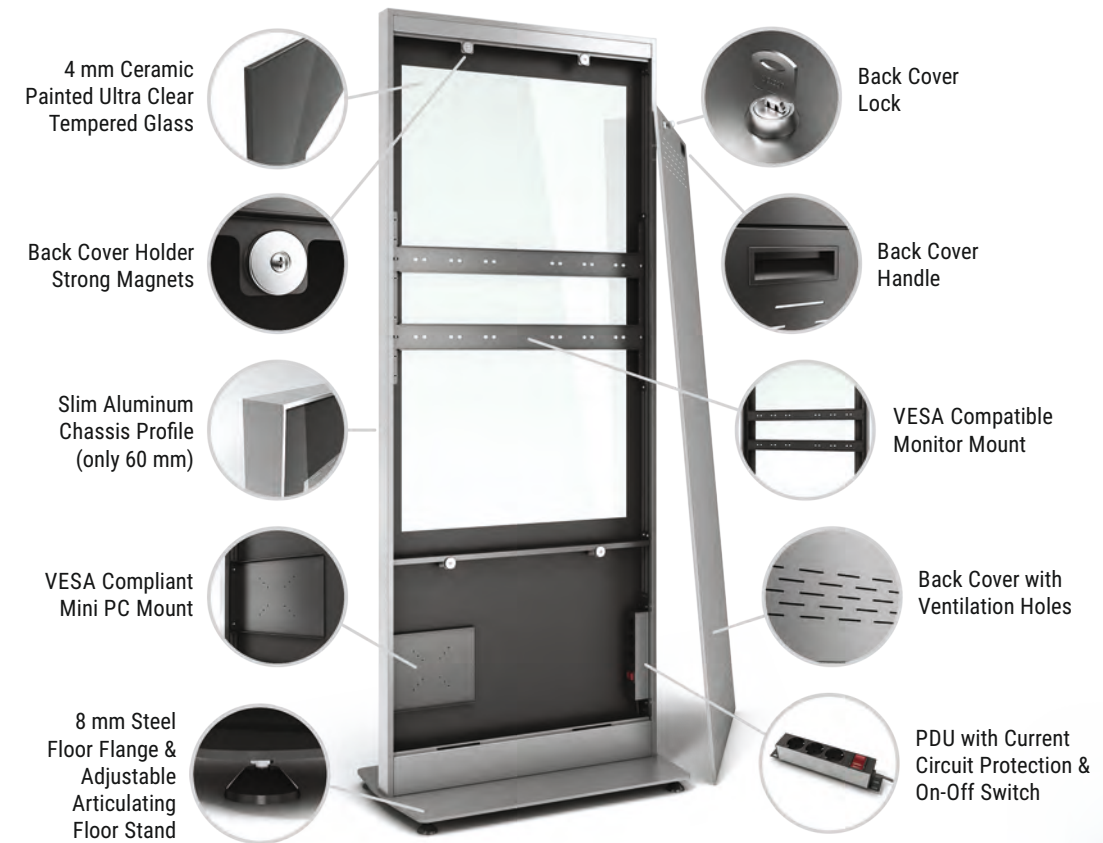

The Cletech C01 Totem Enclosure is a specially designed product that strikes the perfect balance between aesthetics and functionality for ultra-thin monitors. Compatible with monitors with a maximum thickness of not more than 35 mm, this totem cabinet is particularly tailored to seamlessly work with models such as the Samsung QBC, QMC, and QHC series, as well as the LG UH5N-E and UH7N-E series. When paired with slim monitors, the enclosure boasts a mere 60 mm depth, providing a sleek and space-saving design.

## Key Features

- Slim Design
- Easy Access for Maintenance
- 4mm Ceramic Painted Tempered Glass
- Available for Floor Mounts
- Easy Monitor-TV Mounting
- Aluminum Main Chasis

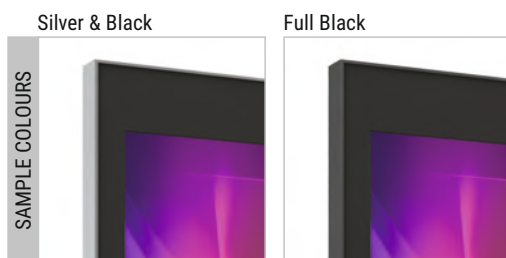

## Main Features

● Included ● Optional ● On Project ● Not Available

Custom Color	Client Logo	Floor Mounts	Base Wheels	Base Feet	Tempered Glass	Lockable Cover	PDU 3 x Socket	Fans for Ventilation	Touch Screen

MONITOR		ENCLOSURE				PACKAGE	
Display (inch)	Mountable Max. Monitor Dimension	Dimension without Flange (WxHxD)	Dimension with Flange (WxHxD)	Weight (kg)	Viewing Area (WxH)	Dimension (WxHxD)	Weight (kg)
32"	435x740x35 mm	576x1839x60 mm	596x1839x400 mm	61	393x698 mm	655x1930x120 mm	64
43"	570x980x35 mm	710x1939x60 mm	730x1939x450 mm	76	529x941 mm	790x2030x120 mm	79
49"	645x1115x35 mm	784x1939x60 mm	804x1939x450 mm	84	604x1074 mm	860x2030x120 mm	87
50"	655x1135x35 mm	797x1939x60 mm	816x1939x450 mm	85	616x1096 mm	870x2030x120 mm	88
55"	720x1250x35 mm	860x2044x60 mm	880x2044x500 mm	100	680x1210 mm	945x2130x120 mm	103
65"	845x1470x35 mm	984x2144x60 mm	1004x2144x550 mm	121	804x1428 mm	1065x2230x120 mm	124
75"	970x1690x35 mm	1112x2244x60 mm	1200x2244x600 mm	156	928x1650 mm	1200x2330x120 mm	159

\* Multiple product package sizes may differ from the information written above. Please get information when you order.



# C05 Indoor Totem Enclosure

Portrait / Single Sided  
49" | 50" | 55" | 65" | 75" | 85"

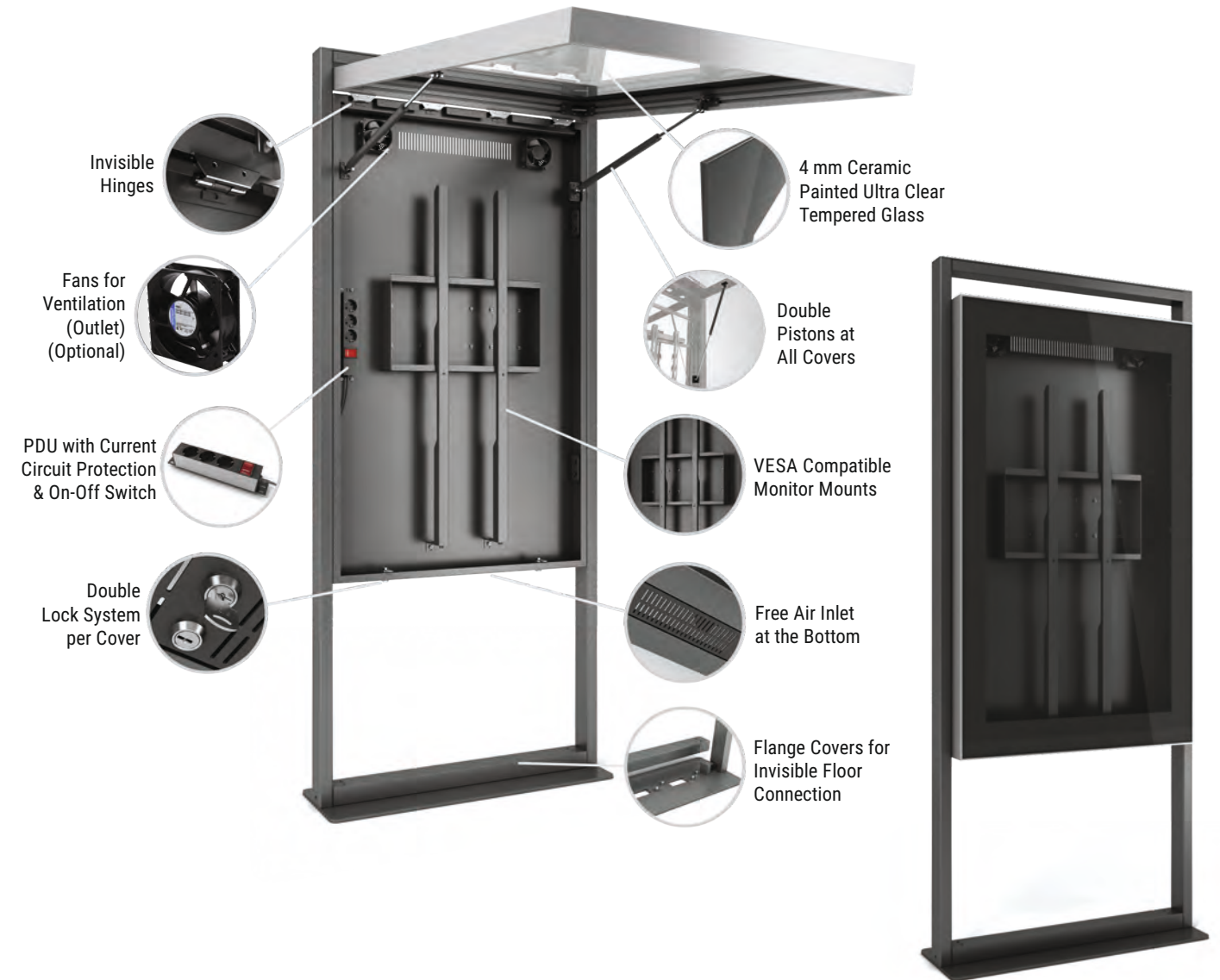
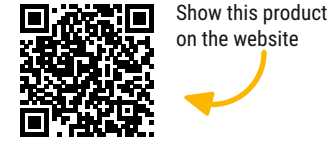

## Key Features

- High Quality Finishes
- Easy Access for Maintenance
- Available for Floor Mounts
- Easy Monitor-TV Mounting
- Lockable Front Covers with Piston

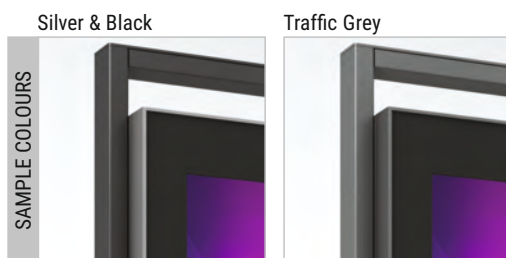

## Main Features

● Included ● Optional ● On Project ● Not Available

Custom Color	Client Logo	Floor Mounts	Base Wheels	Base Feet	Tempered Glass	Lockable Cover	PDU 3 x Socket	Fans for Ventilation	Touch Screen

MONITOR			ENCLOSURE			PACKAGE	
Display (inch)	Mountable Max. Monitor Dimension	Dimension (WxHxD)	Flange (WxD)	Weight (kg)	Viewing Area (WxH)	Dimension (WxHxD)	Weight (kg)
49"	645x1115x100 mm	861x2125x148 mm	861x300 mm	115	604x1074 mm	900x2170x340 mm	123
50"	655x1135x100 mm	861x2125x148 mm	861x300 mm	115	616x1096 mm	900x2170x340 mm	123
55"	720x1250x100 mm	937x2225x148 mm	937x300 mm	130	680x1210 mm	980x2270x340 mm	138
65"	845x1470x100 mm	1061x2325x148 mm	1061x300 mm	140	804x1428 mm	1100x2370x340 mm	150
75"	970x1690x100 mm	1185x2525x148 mm	1185x400 mm	165	928x1650 mm	1250x2570x440 mm	180
85"	1095x1910x100 mm	1310x2625x148 mm	1310x450 mm	195	1053x1872 mm	1400x2720x490 mm	235

\* Multiple product package sizes may differ from the information written above. Please get information when you order.



# X02 Indoor Totem Enclosure

Portrait / Single Sided  
49" | 50" | 55" | 65" | 75" | 85" | 98"



## Key Features

- High Quality Finishes
- Easy Access for Maintenance from Back Cover
- 4mm Ceramic Painted Tempered Glass
- Available for Floor Mounts
- Easy Monitor-TV Mounting
- Aluminum Main Chasis

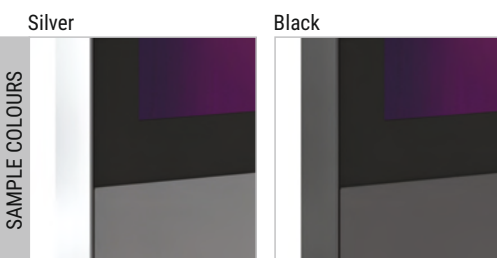

## Main Features

● Included ● Optional ● On Project ● Not Available

Custom Color	Client Logo	Floor Mounts	Base Wheels	Base Feet	Tempered Glass	Lockable Cover	PDU 3 x Socket	Fans for Ventilation	Touch Screen

Display (inch)	MONITOR		ENCLOSURE		PACKAGE	
	Mountable Max. Monitor Dimension	Dimension (WxHxD)	Weight (kg)	Viewing Area (WxH)	Dimension (WxHxD)	Weight (kg)
49"	645x1115x100 mm	748x2023x190 mm	125	604x1074 mm	2100x910x230	150
50"	655x1135x100 mm	748x2023x190 mm	125	616x1096 mm	2100x910x230	150
55"	720x1250x100 mm	862x2023x190 mm	132	680x1210 mm	2100x1020x230	160
65"	845x1470x100 mm	986x2023x190 mm	145	804x1428 mm	2100x1150x230	175
75"	970x1690x100 mm	1110x2144x190 mm	159	928x1650 mm	2250x1270x230	190
85"	1095x1910x100 mm	1240x2300x190 mm	210	1053x1872 mm	2400x1400x230	240
98"	1255x2200x100 mm	1397x2600x190 mm	280	1214x2159 mm	2700x1560x230	325

\* Multiple product package sizes may differ from the information written above. Please get information when you order.





Show this product on the website

## TWO KINDS OF DESIGN WITH STRAIGHT AND HORIZONTAL ANGLE



MIB



MIA

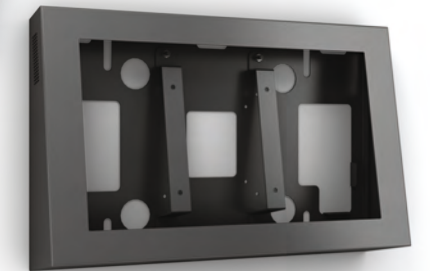
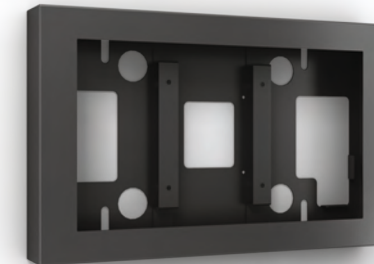
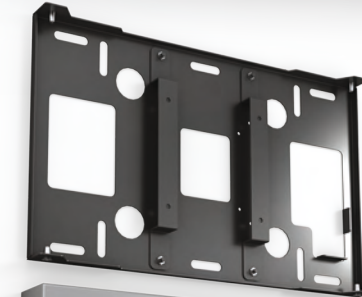

### Key Features

- High Quality Finishes
- Easy Access for Maintenance
- Available for Wall Mounts
- Easy Monitor-TV Mounting
- The All-metal Body

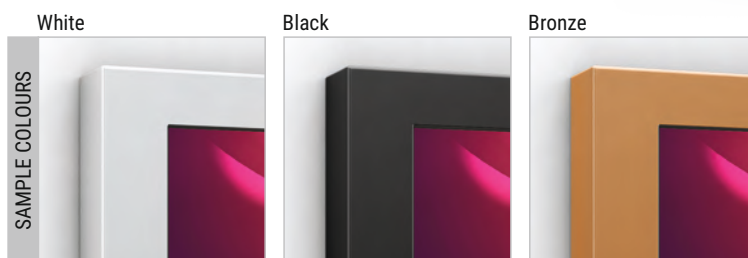

### Main Features

● Included ● Optional ● On Project ● Not Available

Custom Color	Client Logo	Ceiling Mounts	Wall Mount	Base Feet	Tempered Glass	Lockable Cover	PDU 3 x Socket	Fans for Ventilation	Touch Screen

MONITOR		ENCLOSURE			PACKAGE	
Display (inch)	Mountable Max. Monitor Dimension	Dimension (WxHxD)	Weight (kg)	Viewing Area (WxH)	Dimension (WxHxD)	Weight (kg)
10"	160x240x35	280x195x47 mm	1,5	135x217 mm	340x55x255 mm	2
13"	190x320x35	360x225x47 mm	2	165x294 mm	420x55x285 mm	2,5
19,5"	265x460x35	500x300x47 mm	2,4	239x435 mm	560x55x360 mm	2,9
21,5"	290x500x35	540x325x47 mm	2,5	268x476 mm	600x55x385 mm	3
24"	320x550x35	590x353x47 mm	3	296x527 mm	650x55x415 mm	3,5
27"	360x620x40	660x395x70 mm	3,4	336x598 mm	720x55x455 mm	4
32"	415x720x40	760x450x70 mm	3,8	393x698 mm	820x55x510 mm	5

\* Multiple product package sizes may differ from the information written above. Please get information when you order.



## M2 Indoor Desktop Monitor Stand

Portrait & Landscape / Single Sided  
13"

cletech



Show this product on the website



### Key Features

- High Quality Finishes
- Available for Desktop Mounts
- Easy Monitor-TV Mounting
- The All-metal Body



Fully Compatible with Samsung  
QB13R, QB13R-T,  
QB13R-B, QB13R-TB  
QB13R-M, QB13R-TM



MONITOR		ENCLOSURE			PACKAGE	
Display (inch)	Monitor Model	Dimension (WxHxD)	Weight (kg)	Viewing Area (WxH)	Dimension (WxHxD)	Weight (kg)
13" Portrait	Samsung QB13R, QB13R-TB, TM	193x318x183 mm	2.5	297x165 mm	250x350x220	3
13" Landscape	Samsung QB13R, QB13R-TB, TM	322x192x183 mm	2.5	165x294 mm	350x250x220	3

\* Multiple product package sizes may differ from the information written above. Please get information when you order.



# B04 Indoor Totem Enclosure

Portrait / Double Sided  
32" | 43" | 49" | 50" | 55" | 65" | 75"



## Key Features

- High Quality Finishes
- Easy Access for Maintenance
- Available for Floor Mounts
- Easy Monitor-TV Mounting
- Lockable Double Sided Covers



## Main Features

● Included ● Optional ● On Project ● Not Available

Custom Color	Client Logo	Floor Mounts	Base Wheels	Base Feet	Tempered Glass	Lockable Cover	PDU 3 x Socket	Fans for Ventilation	Touch Screen

MONITOR		ENCLOSURE				PACKAGE	
Display (inch)	Mountable Max. Monitor Dimension	Dimension without Flange (WxHxD)	Dimension with Flange (WxHxD)	Weight (kg)	Viewing Area (WxH)	Dimension (WxHxD)	Weight (kg)
32"	435x740x70 mm	579x1877x180 mm	579x1877x450 mm	52	393x698 mm	1950x640x230 mm	56
43"	570x980x70 mm	715x1977x180 mm	715x1977x500 mm	62	529x941 mm	2050x760x230 mm	66
49"	645x1115x70 mm	790x1977x180 mm	790x1977x500 mm	64	604x1074 mm	2050x840x230 mm	70
50"	655x1135x70 mm	796x1977x180 mm	796x1977x500 mm	64	616x1096 mm	2050x840x230 mm	70
55"	720x1250x70 mm	860x1977x180 mm	860x1977x500 mm	68	680x1210 mm	2050x900x230 mm	72
65"	845x1470x70 mm	983x2177x180 mm	983x2177x550 mm	73	804x1428 mm	2250x1040x230 mm	78
75"	970x1690x70 mm	1112x2225x180 mm	1112x2225x600 mm	82	928x1650 mm	2250x1160x230 mm	87

\* Multiple product package sizes may differ from the information written above. Please get information when you order.





Show this product on the website

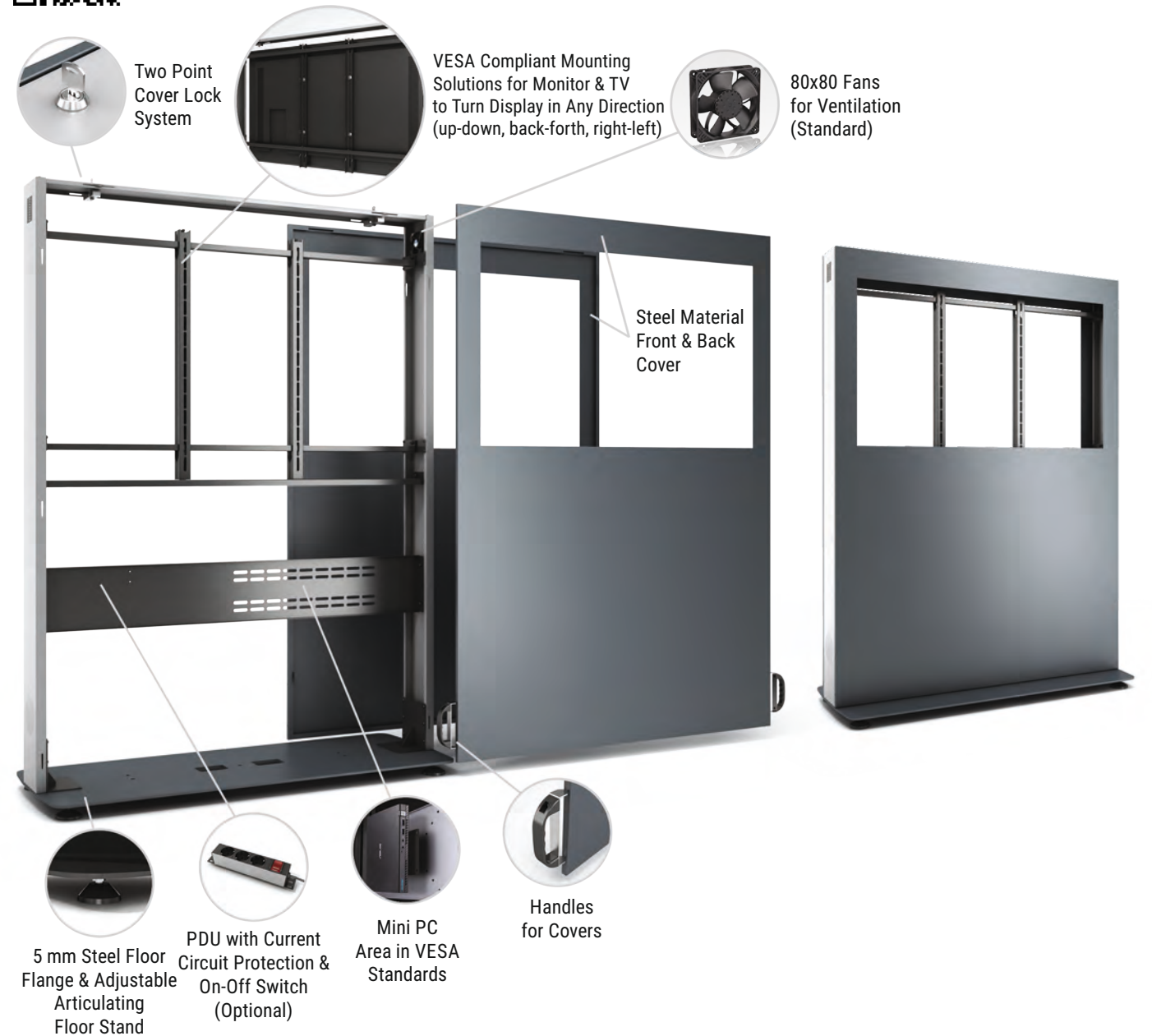

**Key Features**

- High Quality Finishes
- Easy Access for Maintenance
- Available for Floor Mounts
- Easy Monitor-TV Mounting
- Lockable Double Sided Covers



Grey & Anthracite

Full Black



**Main Features**

● Included ● Optional ● On Project ● Not Available

Custom Color	Client Logo	Floor Mounts	Base Wheels	Base Feet	Tempered Glass	Lockable Cover	PDU 3 x Socket	Fans for Ventilation	Touch Screen

MONITOR		ENCLOSURE				PACKAGE	
Display (inch)	Mountable Max. Monitor Dimension	Dimension without Flange (WxHxD)	Dimension with Flange (WxHxD)	Weight (kg)	Viewing Area (WxH)	Dimension (WxHxD)	Weight (kg)
32"	740x740x70 mm	890x1844x186 mm	890x1844x500 mm	48	698x393 mm	950x1900x240 mm	50
43"	980x570x70 mm	1126x1844x186 mm	1126x1844x500 mm	66	941x529 mm	1180x1900x240 mm	69
49"	1115x645x70 mm	1261x1844x186 mm	1261x1844x500 mm	70	1074x604 mm	1330x1900x240 mm	74
50"	1135x655x70 mm	1276x1844x186 mm	1276x1844x500 mm	70	1096x616 mm	1330x1900x240 mm	74
55"	1250x720x70 mm	1390x1900x186 mm	1390x1900x500 mm	76	1210x680 mm	1440x1950x240 mm	80

\* Multiple product package sizes may differ from the information written above. Please get information when you order.



# C06 Indoor Totem Enclosure

Portrait / Double Sided  
49" | 50" | 55" | 65" | 75" | 85"



Show this product on the website

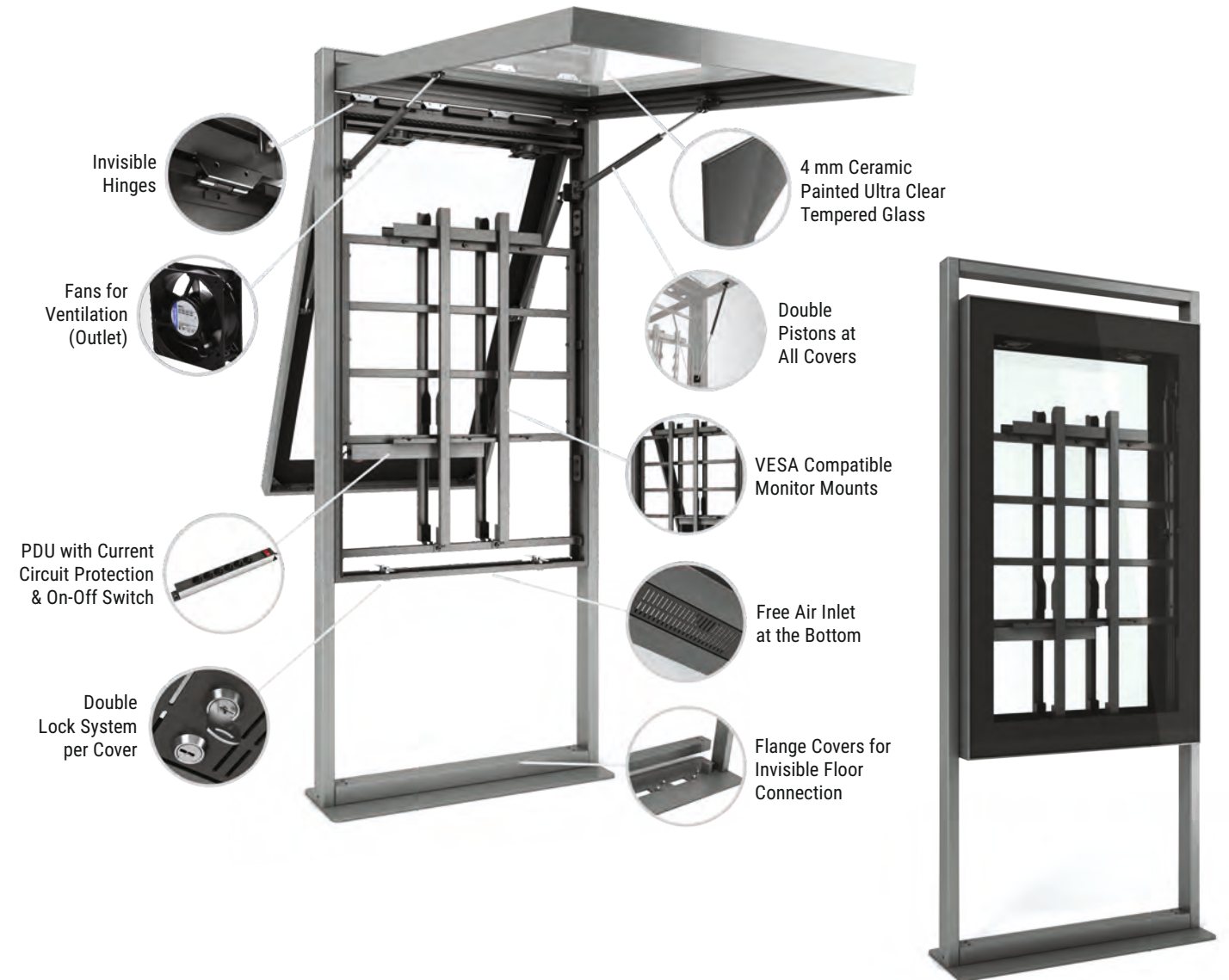

## Key Features

- High Quality Finishes
- Easy Access for Maintenance
- Available for Floor Mounts
- Easy Monitor-TV Mounting
- Lockable Double Covers with Piston



## Main Features

● Included ● Optional ● On Project ● Not Available

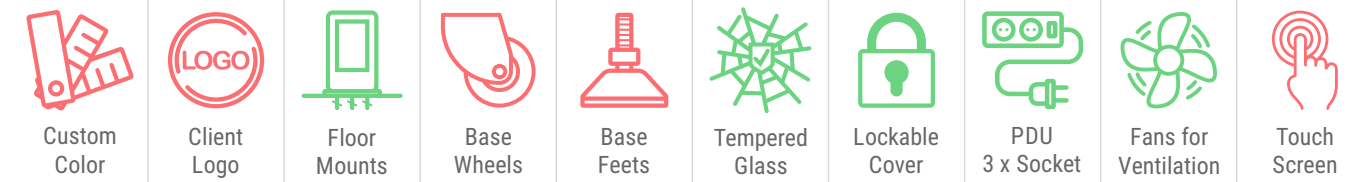

MONITOR			ENCLOSURE			PACKAGE	
Display (inch)	Mountable Max. Monitor Dimension	Dimension (WxHxD)	Flange (WxD)	Weight (kg)	Viewing Area (WxH)	Dimension (WxHxD)	Weight (kg)
49"	645x1115x100 mm	861x2125x215 mm	861x300 mm	123	604x1074 mm	900x2170x340 mm	131
50"	655x1135x100 mm	861x2125x215 mm	861x300 mm	123	616x1096 mm	900x2170x340 mm	131
55"	720x1250x100 mm	937x2225x215 mm	937x300 mm	138	680x1210 mm	980x2270x340 mm	146
65"	845x1470x100 mm	1061x2325x215 mm	1061x300 mm	148	804x1428 mm	1100x2370x340 mm	160
75"	970x1690x100 mm	1185x2525x215 mm	1185x400 mm	175	928x1650 mm	1250x2570x440 mm	190
85"	1095x1910x100 mm	1310x2625x215 mm	1310x450 mm	210	1053x1872 mm	1400x2720x490 mm	250

\* Multiple product package sizes may differ from the information written above. Please get information when you order.



# X01 Indoor Totem Enclosure

Portrait / Double Sided  
43" | 49" | 50" | 55" | 65" | 75"

cletech



## Key Features

- Easy Access for Maintenance from Both Sides
- 4mm Ceramic Painted Tempered Glass
- Available for Floor Mounts
- Easy Monitor-TV Mounting
- Aluminum Main Chasis
- Version A : Angled Glass Front Cover
- Version B : Half Glass Front Cover
- Version C : Half Glass Front Cover & Half Side Profile
- Version D : Full Glass Front Cover

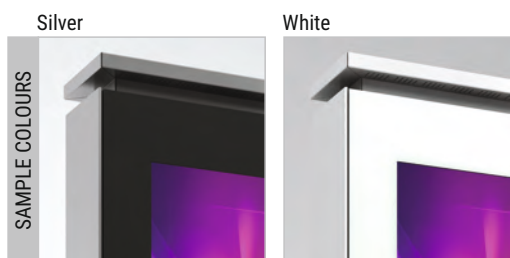

Show this product on the website



## Main Features

● Included ● Optional ● On Project ● Not Available

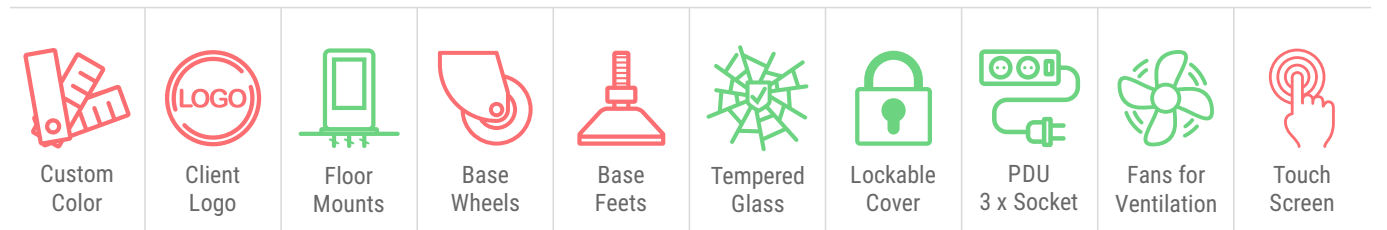

MONITOR		ENCLOSURE			PACKAGE		
Display (inch)	Mountable Max. Monitor Dimension	Dimension without Flange (WxHxD)	Dimension with Flange (WxHxD)	Weight (kg)	Viewing Area (WxH)	Dimension (WxHxD)	Weight (kg)
43"	570x980x55 mm	759x2105x190 mm	759x2105x400 mm	96	529x941 mm	2200x920x450 mm	100
49"	645x1115x55 mm	820x2105x190 mm	820x2105x400 mm	110	604x1074 mm	2200x1000x450 mm	116
50"	655x1135x55 mm	835x2105x190 mm	835x2105x400 mm	110	616x1096 mm	2200x1000x450 mm	116
55"	720x1250x55 mm	896x2209x190 mm	896x2209x400 mm	121	680x1210 mm	2300x1080x450 mm	130
65"	845x1470x55 mm	1020x2209x190 mm	1020x2209x400 mm	138	804x1428 mm	2300x1120x450 mm	150
75"	970x1690x55 mm	1149x2435x190 mm	1149x2435x400 mm	154	928x1650 mm	2500x1280x450 mm	165

\* Multiple product package sizes may differ from the information written above. Please get information when you order.



# XL Indoor Totem Enclosure

Landscape / Double Sided  
43" | 49" | 50" | 55"



## Key Features

- High Quality Finishes
- Easy Access for Maintenance from Both Sides
- 4mm Ceramic Painted Tempered Glass
- Available for Floor Mounts
- Easy Monitor-TV Mounting
- Aluminum Main Chasis



## Main Features

● Included ● Optional ● On Project ● Not Available

Custom Color	Client Logo	Floor Mounts	Base Wheels	Base Feet	Tempered Glass	Lockable Cover	PDU 3 x Socket	Fans for Ventilation	Touch Screen

MONITOR		ENCLOSURE			PACKAGE		
Display (inch)	Mountable Max. Monitor Dimension	Dimension without Flange (WxHxD)	Dimension with Flange (WxHxD)	Weight (kg)	Viewing Area (WxH)	Dimension (WxHxD)	Weight (kg)
43"	980x570x55 mm	1128x1844x190 mm	1128x1844x400 mm	100	941x529 mm	1950x1260x450 mm	104
49"	1115x645x55 mm	1261x1844x190 mm	1261x1844x400 mm	106	1074x604 mm	1950x1420x450 mm	110
50"	1135x655x55 mm	1283x1844x190 mm	1283x1844x400 mm	106	1096x616 mm	1950x1460x450 mm	110
55"	1250x720x55 mm	1397x1920x190 mm	1397x1920x400 mm	117	1210x680 mm	2000x1500x450 mm	122

\* Multiple product package sizes may differ from the information written above. Please get information when you order.





Show this product on the website



Key Features

- High Quality Finishes
- Easy Access for Maintenance
- 4mm Ceramic Painted Tempered Glass
- Available for Floor Mounts
- Easy Monitor-TV Mounting
- Aluminum Main Chasis

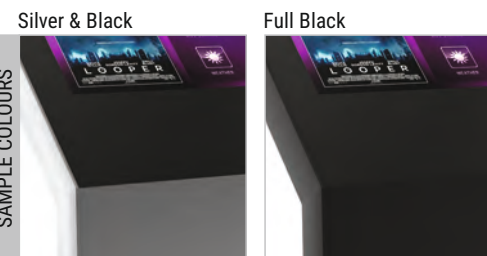

Main Features

● Included ● Optional ● On Project ● Not Available

Custom Color	Client Logo	Floor Mounts	Base Wheels	Base Feet	Tempered Glass	Lockable Cover	PDU 3 x Socket	Fans for Ventilation	Touch Screen

MONITOR		ENCLOSURE			PACKAGE		
Display (inch)	Mountable Max. Monitor Dimension	Dimension (WxHxD)	Stand Dimension (WxHxD)	Weight (kg)	Viewing Area (WxH)	Dimension (WxHxD)	Weight (kg)
32"	435x740x55 mm	878x1385x672 mm	505 mm	55	698x393 mm	942x1565x672 mm	60
43"	570x980x55 mm	1121x1385x872 mm	505 mm	58	941x529 mm	1222x1565x872 mm	63
49"	645x1115x55 mm	1121x1385x872 mm	505 mm	58	1074x604 mm	1222x1565x872 mm	63
50"	655x1135x55 mm	1400x1550x850 mm	505 mm	68	1096x616 mm	1400x1550x850 mm	72

\* Multiple product package sizes may differ from the information written above. Please get information when you order.



# ZS Indoor Self-Service Kiosk Enclosure

Portrait / Single Sided  
10" | 13" | 19.5" | 21.5" | 24" | 27" | 32"

cletech



Show this product on the website

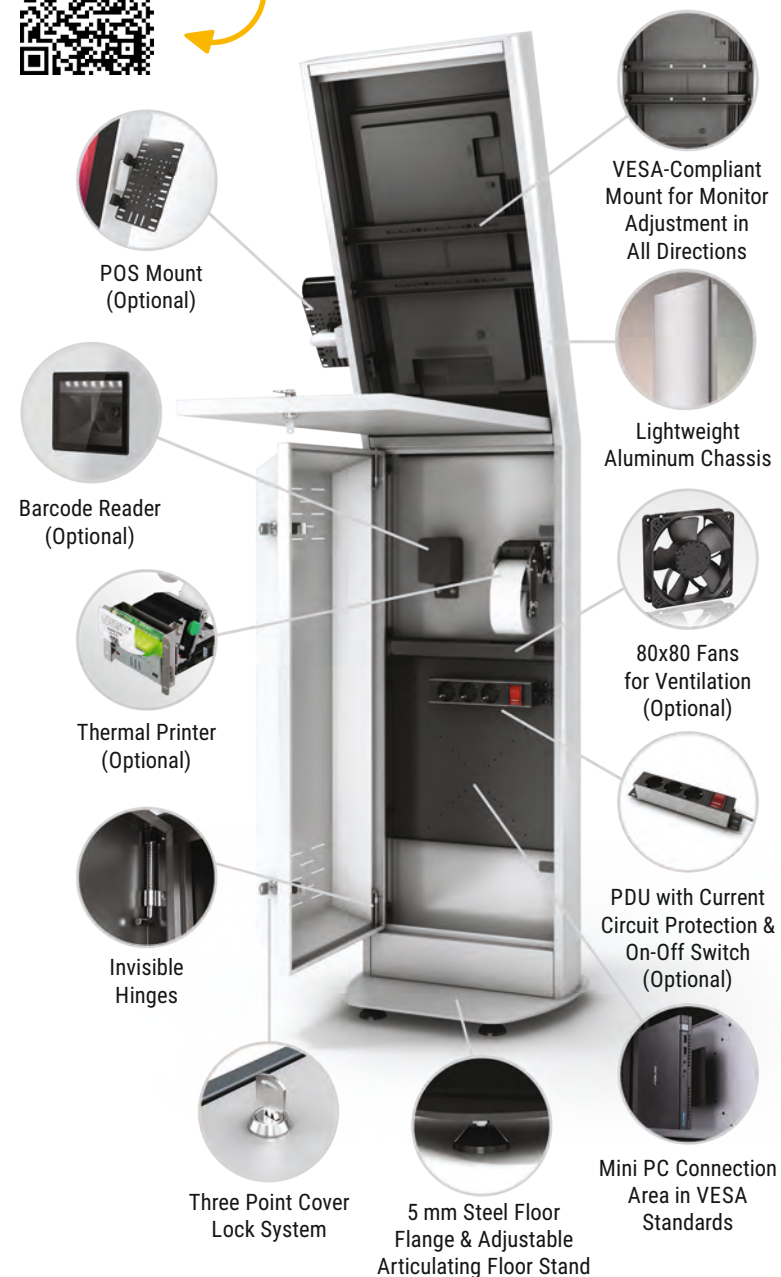

## Key Features

- Aluminum Main Chasis
- High Quality Finishes
- Easy Access for Maintenance
- Available for Floor Mounts
- Easy Monitor & PC Mounting
- POS, Printer and Barcode Scanner Option

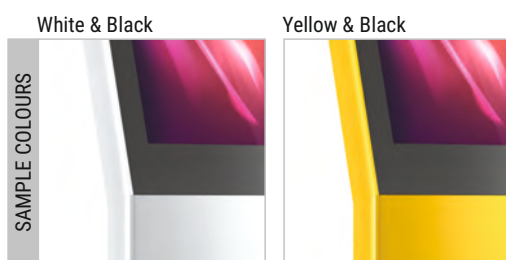

## Main Features

● Included ● Optional ● On Project ● Not Available

Custom Color	Client Logo	Floor Mounts	Base Wheels	Base Feet	Tempered Glass	Lockable Cover	PDU 3 x Socket	Fans for Ventilation	Touch Screen

MONITOR		ENCLOSURE				PACKAGE	
Display (inch)	Mountable Max. Monitor Dimension	Dimension without Flange (WxHxD)	Dimension with Flange (WxHxD)	Weight (kg)	Viewing Area (WxH)	Dimension (WxHxD)	Weight (kg)
10"	175x255x55 mm	380x1646x205 mm	400x1646x350 mm	36	135x217 mm	440x1700x300 mm	39
13"	205x335x55 mm	410x1646x205 mm	430x1646x350 mm	38	165x294 mm	470x1700x300 mm	41
19.5"	280x475x55 mm	355x1700x300 mm	375x1700x350 mm	51	239x435 mm	400x1750x400 mm	54
21.5"	310x515x55 mm	385x1700x324 mm	405x1700x350 mm	54	268x476 mm	430x1750x400 mm	57
24"	335x565x55 mm	413x1747x346 mm	433x1747x350 mm	56	296x527 mm	480x1800x400 mm	59
27"	375x640x55 mm	449x1811x369 mm	469x1811x450 mm	58	336x598 mm	500x1850x420 mm	61
32"	435x740x55 mm	507x1908x404 mm	527x1908x450 mm	61	393x698 mm	625x1960x500 mm	64

\* Multiple product package sizes may differ from the information written above. Please get information when you order.





Show this product on the website

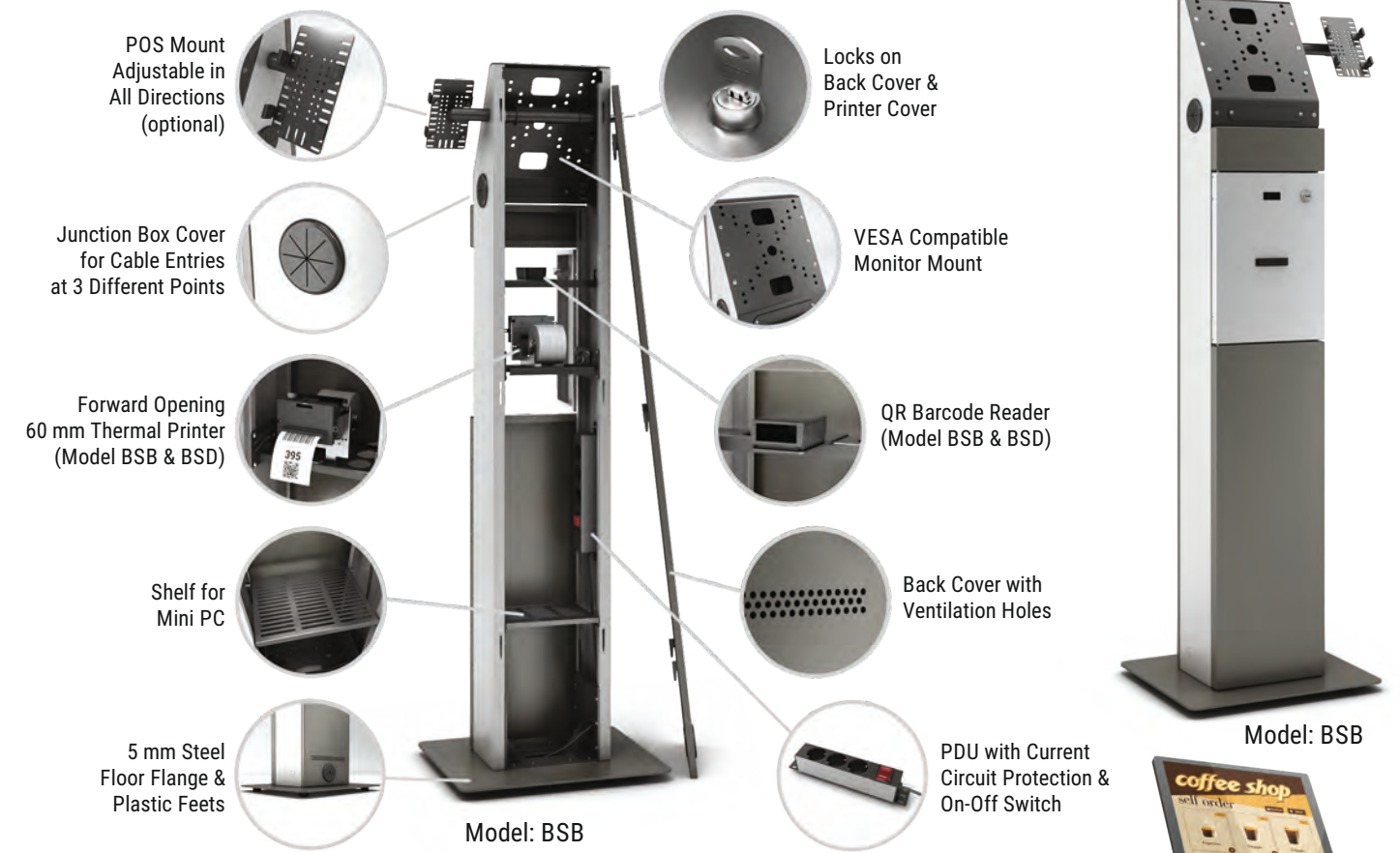

**Key Features**

- High Quality Finishes
- Easy Access for Maintenance
- Available for Floor Mounts
- Easy Monitor-TV Mounting
- Lockable Back & Front Covers
- Compatible with All Touch Monitors



BS Series Self Service Kiosk is designed for multi-purpose. It is produced in 4 types.

BSA: Standalone, No Additional Hardware

BSB: Standalone, Thermal Printer and QR Barcode Reader

BSC: Desktop, No Additional Hardware

BSD: Desktop, Thermal Printer and QR Barcode Reader

**Main Features**

● Included ● Optional ● On Project ● Not Available

Custom Color	Client Logo	Floor Mounts	Base Wheels	Base Feet	Tempered Glass	Lockable Cover	PDU 3 x Socket	Fans for Ventilation	Touch Screen

MONITOR		ENCLOSURE			PACKAGE	
Model Code	Mountable Max. Monitor Dimension	Dimension (WxHxD)	Flange (WxD)	Weight (kg)	Dimension (WxHxD)	Weight (kg)
BSA	435x740 mm	250x1440x180 mm	440x370 mm	32	290x1900x220 mm	36
BSB	435x740 mm	250x1440x180 mm	440x370 mm	35	290x1440x220 mm	39
BSC	435x740 mm	250x580x180 mm	440x370 mm	18	290x620x220 mm	21
BSD	435x740 mm	250x580x180 mm	440x370 mm	21	290x620x220 mm	24

\* Multiple product package sizes may differ from the information written above. Please get information when you order.



# XK Indoor Kiosk Enclosure

Landscape/ Single Sided  
43" | 49" | 50" | 55" | 65"



cletech

10 Point PCAP Touch with 4 mm  
Anti-Glare Tempered Glass



Show this product  
on the website



## Key Features

- High Quality Finishes
- Lockable area for PC-Media Player
- Available for Floor Mounts
- 10 Point PCAP Touch with Anti-Glare Glass
- Easy Monitor-TV Mounting
- Aluminum Main Chasis



## Main Features

● Included ● Optional ● On Project ● Not Available

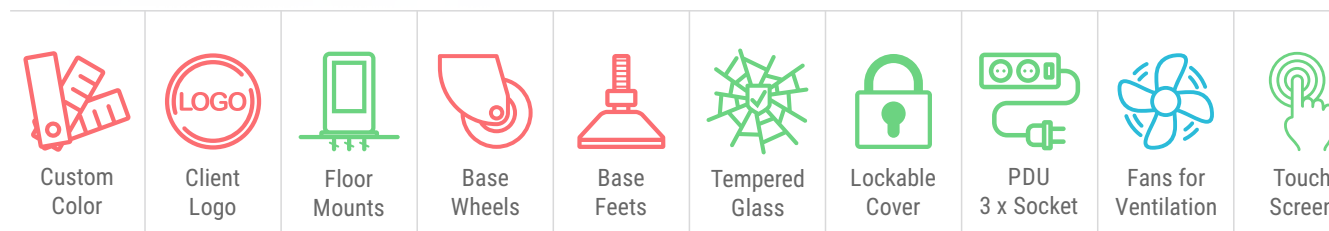

MONITOR		ENCLOSURE			PACKAGE		
Display (inch)	Mountable Max. Monitor Dimension	Dimension (WxHxD)	Flange Dimension (WxD)	Weight (kg)	Viewing Area (WxH)	Dimension (WxHxD)	Weight (kg)
43"	980x570x55 mm	1177x1230x676 mm	721x400 mm	92	941x529 mm	1280x1380x780 mm	127
49"	1115x645x55 mm	1332x1255x763 mm	876x400 mm	110	1074x604 mm	1430x1400x860 mm	140
50"	1135x655x55 mm	1332x1255x763 mm	876x400 mm	110	1096x616 mm	1430x1400x860 mm	140
55"	1250x720x55 mm	1446x1273x827 mm	990x400 mm	125	1210x680 mm	1550x1430x930 mm	155
65"	1470x850x55 mm	1664x1335x890 mm	1200x450 mm	142	1428x804 mm	1770x1500x1000 mm	178

\* Multiple product package sizes may differ from the information written above. Please get information when you order.



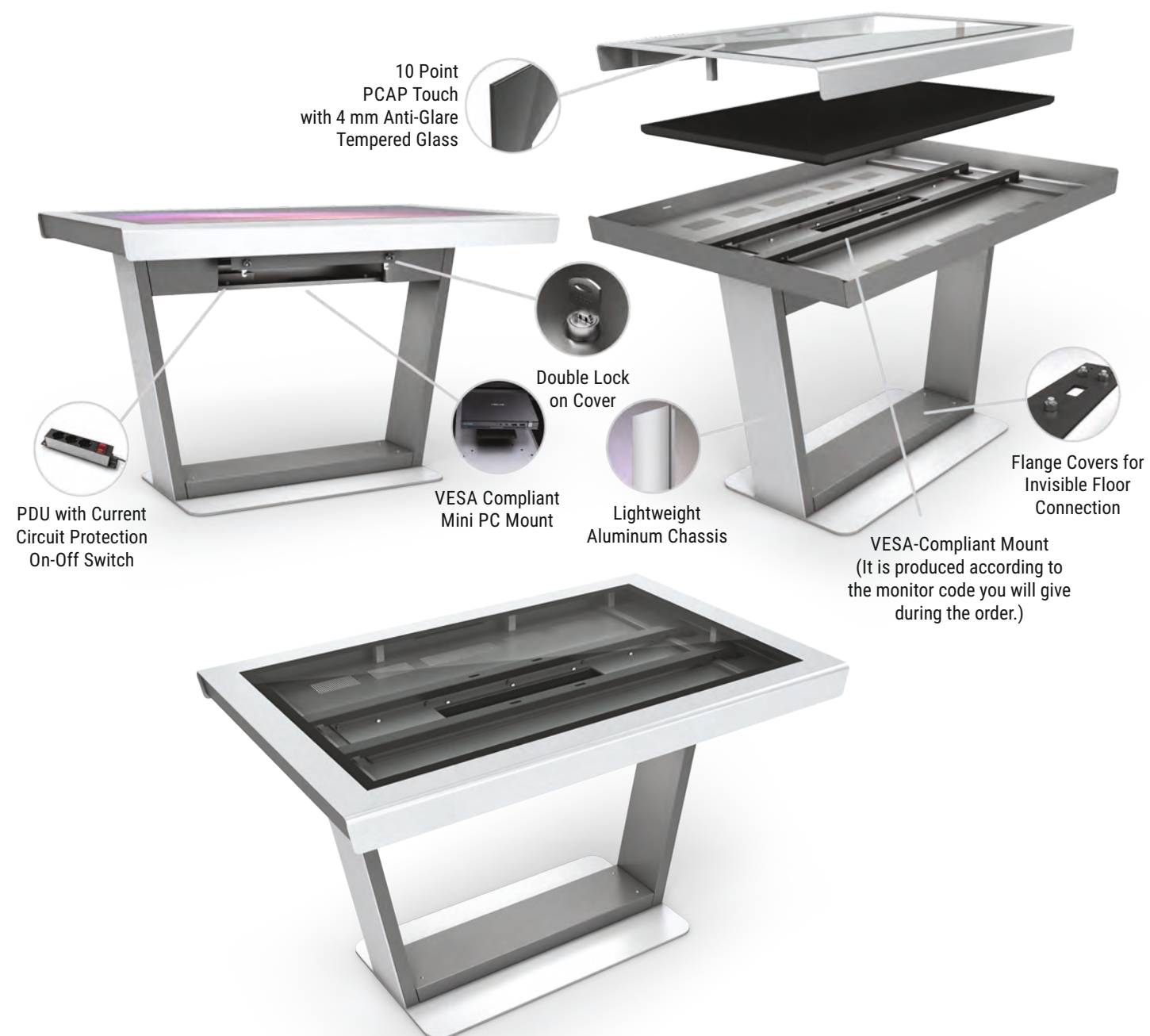
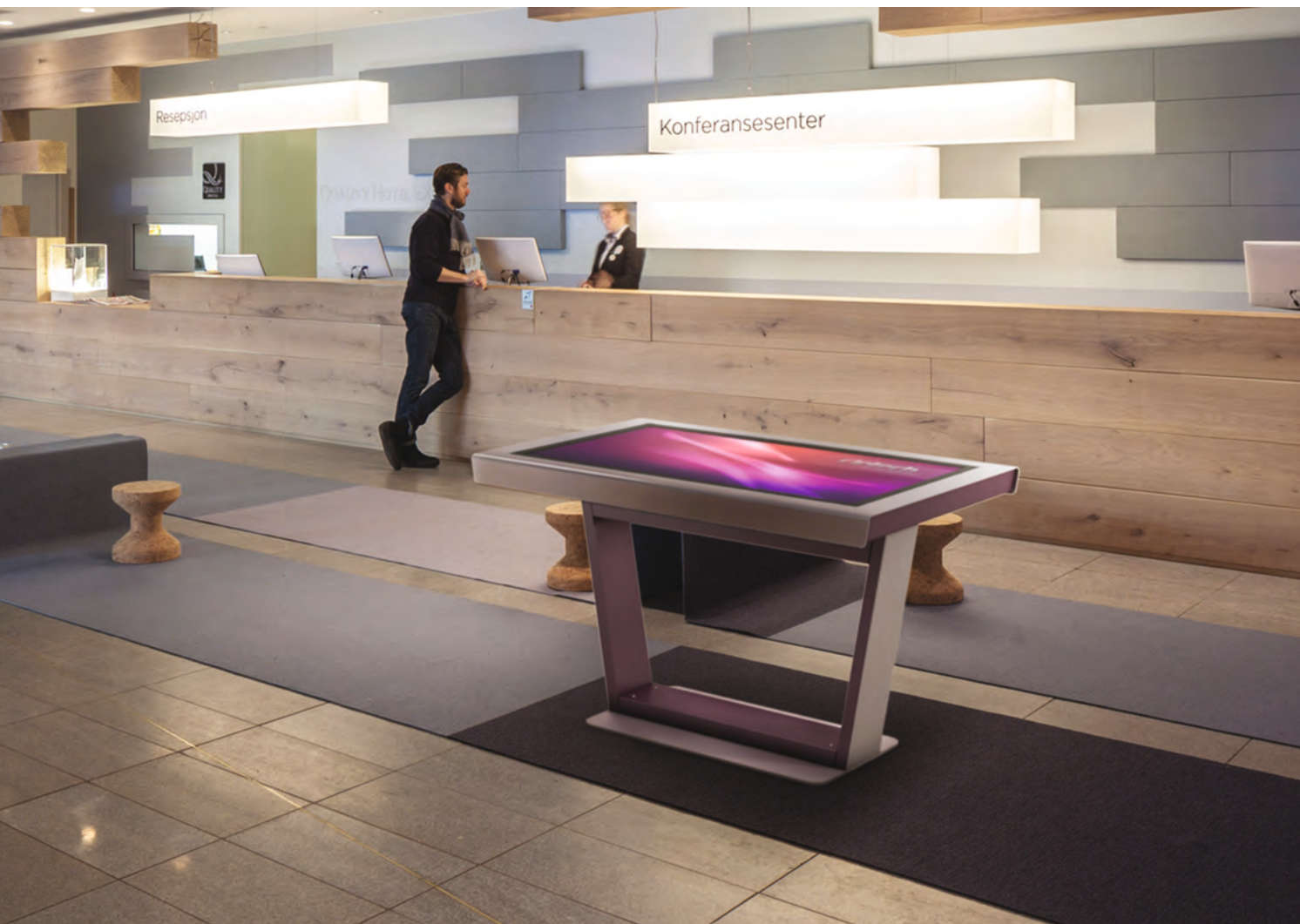

**Key Features**

- High Quality Finishes
- Lockable area for PC-Media Player
- 10 Point PCAP Touch with Anti-Glare Glass
- Available for Floor Mounts
- Easy Monitor-TV Mounting
- Aluminum Main Chasis

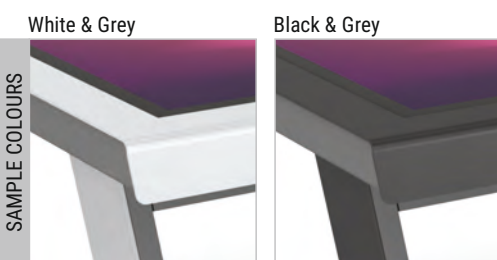

**Main Features**

● Included    ● Optional    ● On Project    ● Not Available

Custom Color	Client Logo	Floor Mounts	Base Wheels	Base Feet	Tempered Glass	Lockable Cover	PDU 3 x Socket	Fans for Ventilation	Touch Screen

MONITOR		ENCLOSURE			PACKAGE		
Display (inch)	Mountable Max. Monitor Dimension	Dimension (WxHxD)	Flange Dimension (WxD)	Weight (kg)	Viewing Area (WxH)	Dimension (WxHxD)	Weight (kg)
43"	980x570x55 mm	1177x1273x759 mm	627x400 mm	102	941x529 mm	1260x1400x840 mm	110
49"	1115x645x55 mm	1310x1273x834 mm	760x500 mm	116	1074x604 mm	1400x1400x920 mm	126
50"	1135x655x55 mm	1332x1273x846 mm	682x500 mm	117	1096x616 mm	1410x1400x930 mm	127
55"	1250x720x55 mm	1446x1273x910 mm	896x500 mm	128	1210x680 mm	1530x1400x990 mm	138
65"	1470x850x55 mm	1664x1273x1034 mm	1200x500 mm	145	1428x804 mm	1880x1400x1100 mm	180

\* Multiple product package sizes may differ from the information written above. Please get information when you order.





The Cletech DP3 Digital Podium is designed for use in indoor stages. This product, which has all the equipment and features that a speaker needs, also allows to inform the audience. The digital podium, which has a 24" touch screen on the speaker side, also has a 24" screen that can be remotely controlled on the audience side.

The speaker screen is offered with a Windows-based PC. It allows to project from the screen that also includes a smart board and presentation software to a projection or other display device. In addition, thanks to the many input and output ports (USB, HDMI in-out, LAN), you can also find solutions to your different scenario needs. On the speaker side there is also a cup holder and a Shure Gooseneck Condenser professional microphone.

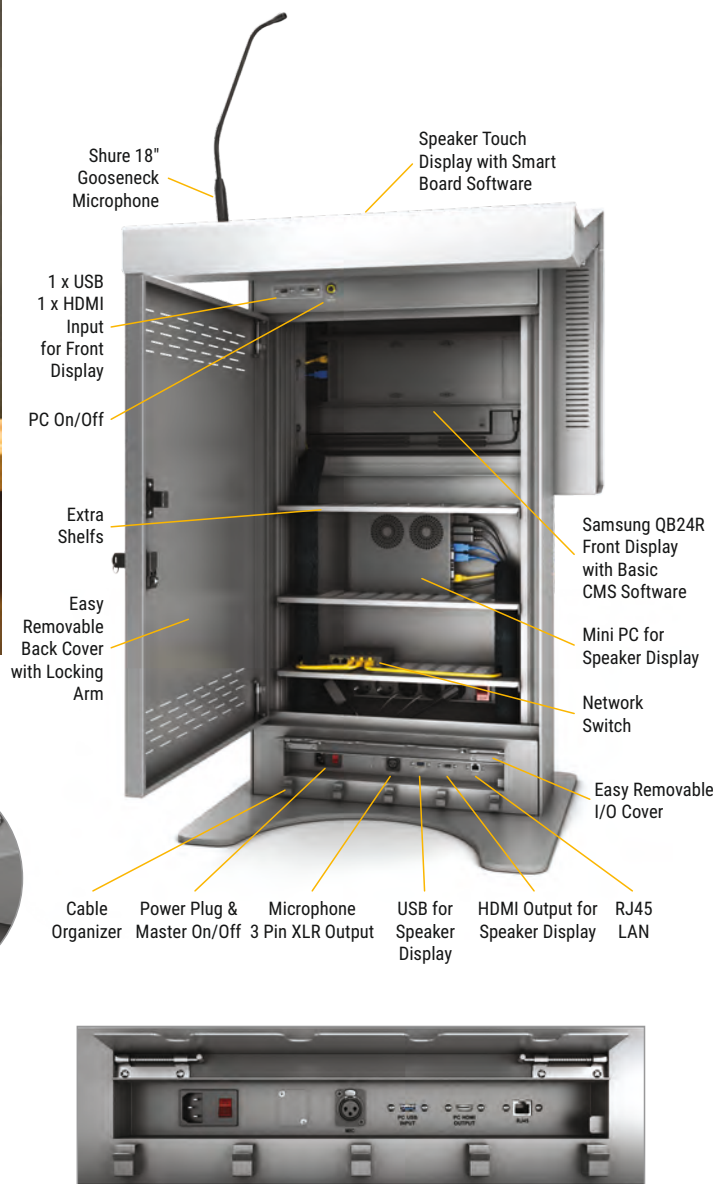

**Key Features**

- Aluminum Main Chassis
- Samsung Professional Monitors
- Shure Professional Microphone
- Multiple Input Output Features
- Smart Board and Presentation Software



Show this product on the website

	Audience Display	Speaker Display	
<b>MONITOR SPECIFICATIONS</b>			
DISPLAY	Monitor	Samsung QB24R-M	Samsung QB24R-TM
	Display Size	24"	24"
	Type	ADS	ADS
	Resolution	Full HD (1920x1080)	Full HD (1920x1080)
	Active Area (mm)	527.04 x 296.46	527.04 x 296.46
	Brightness	250 Nit	250 Nit
	Contrast	1000:1	1000:1
	Viewing Angle	178/178	178/178
	Response Time	14 ms.	14 ms.
	Display Colors	16.7 Million	16.7 Million
	Color Gamut	%72	%72
	Operation Hour	16/7	16/7
	CONNECTIVITY	Speaker	5 Watt
Inputs		1xHDMI 1.4, 1xHDCP 2.2, 1xUSB 2.0	
Outputs		Stereo Mini Jack, Touch Output (QB24R-T)	
External Control		RS232C, RJ45	
OPERATION	Power Type	Internal	
	Power Supply	AC 100 - 240 V~ (+/- 10 %), 50/60 Hz	
	Power Con. (Max.)	38.5 Watt/Hour	38.5 Watt/Hour
	Power Con. (Nor.)	25 Watt/Hour	28 Watt/Hour
	Power Con. (Typ.)	35 Watt/Hour	35 Watt/Hour
	Operating Temp.	0°C~ 40°C	0°C~ 40°C
	Humidity	%10~80	%10~80
	DIMENSIONS	Outline (mm)	547.9x334.4x31.8
Package (mm)		620x419x122	620x419x122
Weight		3 kg.	3 kg.
Package Weight		4.1 kg	4.1 kg
Bezel Width		17.9 mm (T/B), 9.4 mm (L/R)	17.9 mm (T/B), 9.4 mm (L/R)
FEATURES	Touch	No	
	Features	Built-in MagicInfo S6, SSSP 6.0, H/W : Temperature Sensor, Pivot Display, Clock Battery (168hrs Clock Keeping), Button Lock, Built in Speaker (5W 1ch), IP5x Rating, LFD Home UI, Plug&Play Wi-Fi/BT S/W : Auto Source Switching & Recovery, Hot key option	
Processor	Cortex A72 1.7GHz Quad-Core CPU		
Cache Memory	L1 Instruction Cache: 48KB, L1 Data Cache: 32KB, L2 Cache: 2MB		
Memory	2.5GB, LPDDR4 1.5GHz 64bit		
Graphics	Graphic Resolution: 1920x1080 Output Resolution: 3840x2160		
Storage	8GB (3.88GB Occupied by O/S, 4.12GB Available)		
Operating System	Tizen 4.0 (VDLinux)		

<b>COMPUTER SPECIFICATIONS</b>	
Processor	Intel® Core™ i5-12500T, 2.20 GHz, 6 Cores
Chipset	Intel® H310 Express
Memory	8GB DDR4 2400MHz
Storage	256GB SSD
I/O	2xUSB 2.0, 4xUSB 3.0, 2xRJ45, 1xHDMI, 1xDisplay Port, 1xAudio-Out, 1xAudio-In
Network	10/100/1000 Gigabit LAN, WiFi Wireless Network
Case	Ultra Mini ITX
Power	90W 19V Adapter
Dimensions	195 x 170 x 45 mm
Operating System	Windows 11 Pro 64 Bit
<b>MICROPHONE SPECIFICATIONS</b>	
Brand/Model	Shure CVG18S-B/C, 18" 45,7 cm Gooseneck Condenser Microphone, Mute Button, LED Light, Cardioid, Black
Cartridge Type	Electret Condenser
Frequency Response	70-16000 Hz
Polar Pattern	Cardioid
Output Impedance	180 Ω
Sensitivity	-33 dBV/Pa[1] (22 mV)
Maximum SPL	120 dB SPL
Signal to Noise Ratio	67 dB
Dynamic Range	93 dB
Self Noise	27 dB SPL
Common Mode Rejec.	>45 dB
Preamplifier Out. Clip. L.	-7 dBV
Polarity	Positive pressure on diaphragm produces positive voltage on pin 2 with respect to pin 3
Power Requirements	11-52 V DC[4], 2.0 mA
Environmental Require.	Operating Temperature Range: -18°C ila 57°C (0°F - 135°F) Humidity: %0 - %95
<b>HOUSING SPECIFICATIONS</b>	
Material	Lightweight Aluminum and Steel Body Parts
Paint	Scratch More Resistant Electrostatic Powder Coating
Fixing	Ground Connection Holes in Cabin
Housing Dimensions	700x1098x611 mm (WxDxH), 95 kg
Packaged Dimensions	800x1250x700 mm (WxDxH), 165 kg
I/O Ports	1 x Switched Main Power Input, 1 x 3-Pin XLR Microphone Out, 3 x USB (Speaker Display), 1 x USB (Front Display), 1 x RJ45, 1 x HDMI Out (Speaker Display), 1 x HDMI In (F. D.)
Power	AC 110-240 V - 50/60 Hz
Power Consumption	≤ 210 Watt



# KS / KD / KW Indoor Self-Order Kiosk Enclosure

Portrait / Single Sided  
22" | 24" | 27" | 32"

cletech



The K Series Indoor Self-Order Kiosk is designed for monitors with built-in touch functionality. It features a modular structure and can be customized based on the specified brands of touch monitors, payment devices, readers, printers, and other hardware during the order process. The kiosk has a durable body made from robust materials and is designed for easy servicing.

## Key Features

- Easy Access for Maintenance
- Compatible for Touch Monitors
- Available Floor Mounts
- Customize for POS Devices
- External Printer Cover for Quick Paper Changes
- Version KS : Indoor Single Sided
- Version KD : Indoor Double Sided
- Version KW : Indoor Wall Mount



Show this product on the website



## Main Features

● Included ● Optional ● On Project ● Not Available

Custom Color	Client Logo	Floor Mounts	Base Wheels	Base Feets	Tempered Glass	Lockable Cover	PDU 6 x Socket	Fans for Ventilation	Touch Screen

MONITOR	ENCLOSURE					PACKAGE	
Display (inch)	Dimension without Stand (WxHxD)	Dimension with Stand (WxHxD)	Weight without Stand	Weight with Stand	Viewing Area (WxH)	Dimension (WxHxD)	Weight (kg)
22"	420x1000x220 mm	420x1770x220 mm	34 kg	51 kg	268x476 mm	1830x480x260 mm	55
24"	470x1050x220 mm	470x1817x220 mm	36 kg	53 kg	324x518 mm	1880x530x260 mm	58
27"	470x1050x220 mm	470x1817x220 mm	36 kg	53 kg	336x598 mm	1880x530x260 mm	58
32"	525x1150x220 mm	525x1917x220 mm	38 kg	55 kg	392x697 mm	1980x580x260 mm	60

\* Multiple product package sizes may differ from the information written above. Please get information when you order.  
\* Weights are given excluding electronic equipment.



# Outdoor Products





# M5 Outdoor Monitor Enclosure

Portrait & Landscape / Single Sided  
32" | 43" | 46" | 49" | 50" | 55" | 65" | 75"

cletech



Show this product on the website

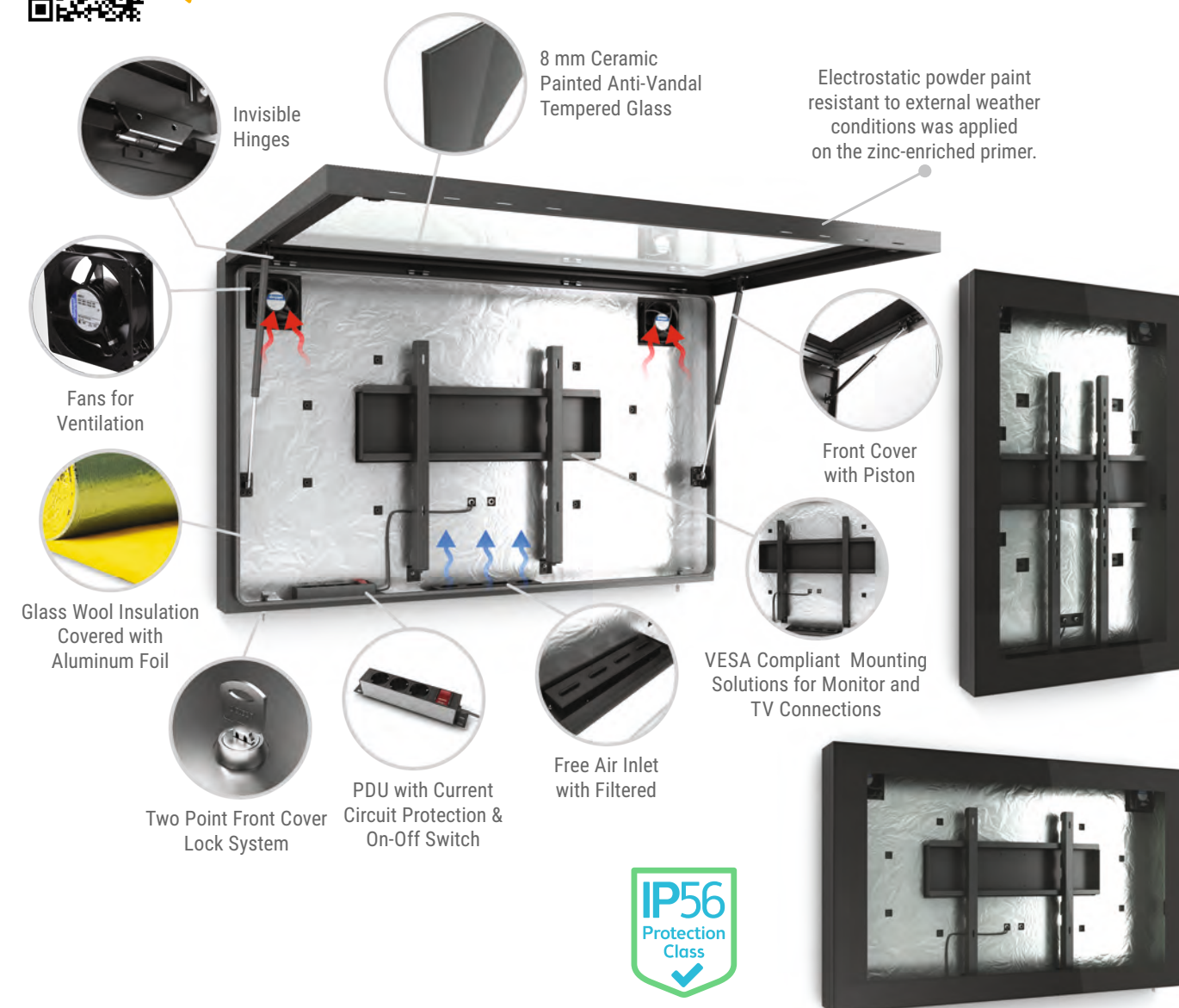

## Key Features

- High Quality Finishes
- Easy Access for Maintenance
- 8 mm Anti-Vandal Tempered Glass
- Available for Wall & Ceiling Mounts
- Easy Monitor-TV Mounting

## Options

- Tangential Fans for Air Curtain
- UV Protected Foil
- Laminated Anti-Reflective IK10 Glass

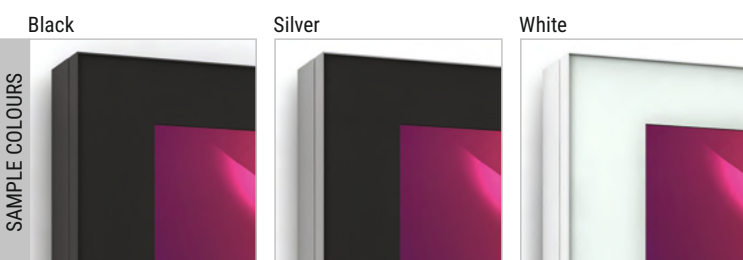

## Main Features

● Included ● Optional ● On Project ● Not Available

Custom Color	Client Logo	Ceiling Mounts	Wall Mount	Base Feet	Tempered Glass	Lockable Cover	PDU 3 x Socket	Fans for Ventilation	Touch Screen

MONITOR		ENCLOSURE			PACKAGE		
Display (inch)	Mountable Max. Monitor Dimension	Dimension without Wall Mount (WxHxD)	Dimension with Wall Mount (WxHxD)	Weight (kg)	Viewing Area (WxH)	Dimension (WxHxD)	Weight (kg)
32"	435x740x100 mm	925x580x160 mm	925x580x203 mm	58	393x698 mm	980x640x220 mm	60
43"	570x980x100 mm	1173x722x160 mm	1173x722x203 mm	68	529x941 mm	630x1040x220 mm	70
46"	615x1060x100 mm	1244x759x160 mm	1244x759x203 mm	70	573x1018 mm	1300x810x220 mm	72
49"	645x1115x100 mm	1300x790x160 mm	1300x790x203 mm	76	604x1074 mm	705x1175x220 mm	79
50"	655x1135x100 mm	1300x790x160 mm	1300x790x203 mm	76	616x1096 mm	705x1175x220 mm	79
55"	720x1250x100 mm	1437x869x160 mm	1437x869x203 mm	87	680x1210 mm	1500x930x220 mm	90
65"	845x1470x100 mm	1654x989x160 mm	1654x989x203 mm	105	804x1428 mm	1720x1050x220 mm	110
75"	970x1690x100 mm	1876x1114x160 mm	1876x1114x203 mm	128	928x1650 mm	1950x1200x250 mm	132

\* Multiple product package sizes may differ from the information written above. Please get information when you order.



# M5B Outdoor Totem Enclosure

Portrait & Landscape / Single Sided  
43" | 46" | 49" | 50" | 55" | 65" | 75"

cletech



Show this product on the website



## Key Features

- Easy Access for Maintenance
- 8mm Anti-Vandal Tempered Glass
- Available for Floor Mounts
- Easy Monitor-TV Mounting

## Options

- Tangential Fans for Air Curtain
- UV Protected Foil
- Laminated Anti-Reflective IK10 Glass
- Heaters with Thermostat (optional)

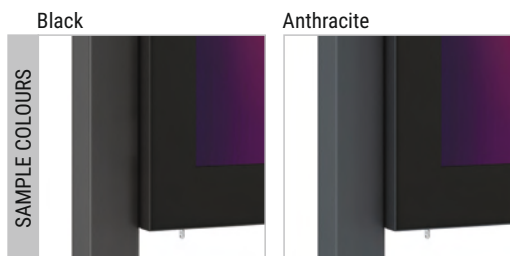

## Main Features

● Included ● Optional ● On Project ● Not Available

Custom Color	Client Logo	Floor Mounts	Base Wheels	Base Feet	Tempered Glass	Lockable Cover	PDU 3 x Socket	Fans for Ventilation	Touch Screen

MONITOR		ENCLOSURE					PACKAGE	
Display (inch)	Mountable Max. Monitor Dimension	Portrait Dimension (WxHxD)	Landscape Dimension (WxHxD)	Feets (WxD)	Weight (kg)	Viewing Area (WxH)	Portrait / Landscape Dimension (WxHxD) (mm)	Weight (kg)
43"	570x980x100 mm	1027x1923x160 mm	1472x1800x160mm	205x205 mm	185	529x941 mm	2000x1200x350 / 1880x320x1550	235
46"	615x1060x100 mm	1064x1995x160 mm	1549x1869x160 mm	205x205 mm	210	573x1018 mm	2100x1160x350 / 1970x320x1650	260
49"	645x1115x100 mm	1095x2050x160 mm	1605x1900x160 mm	205x205 mm	235	604x1074 mm	2150x1200x350 / 2000x320x1700	285
50"	655x1135x100 mm	1110x2050x160 mm	1620x1900x160 mm	205x205 mm	235	616x1096 mm	2150x1210x350 / 2000x320x1710	285
55"	720x1250x100 mm	1174x2187x160 mm	1742x1978x160 mm	205x205 mm	255	680x1210 mm	2250x1200x350 / 2100x320x1650	305
65"	845x1470x100 mm	1295x2404x160 mm	1866x2100x160 mm	205x205 mm	275	804x1428 mm	2500x1400x350 / 2200x320x1970	325
75"	970x1690x100 mm	1424x2437x160 mm	2185x2227x160 mm	205x205 mm	295	928x1650 mm	2350x1450x350 / 2200x320x2100	360

\* Multiple product package sizes may differ from the information written above. Please get information when you order.



# M5C Outdoor Totem Enclosure

Portrait / Single Sided  
43" | 46" | 49" | 50" | 55" | 65" | 75"

cletech



Show this product on the website



## Key Features

- Easy Access for Maintenance
- 8mm Anti-Vandal Tempered Glass
- Available for Floor Mounts
- LED Illuminated Lightbox

## Options

- Tangential Fans for Air Curtain
- UV Protected Foil
- Laminated Anti-Reflective IK10 Glass
- Heaters with Thermostat (optional)

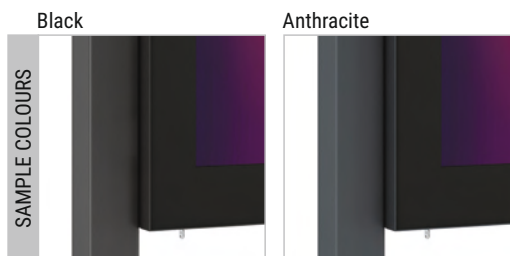

## Main Features

● Included ● Optional ● On Project ● Not Available

Custom Color	Client Logo	Floor Mounts	Base Wheels	Base Feet	Tempered Glass	Lockable Cover	PDU 3 x Socket	Fans for Ventilation	Touch Screen

MONITOR		ENCLOSURE				PACKAGE	
Display (inch)	Mountable Max. Monitor Dimension	Dimension (WxHxD)	Feets (WxD)	Weight (kg)	Viewing Area (WxH)	Dimension (WxHxD)	Weight (kg)
43"	570x980x100 mm	1027x2136x160 mm	205x205 mm	182	529x941 mm	2250x1150x350 mm	222
46"	615x1060x100 mm	1064x2208x160 mm	205x205 mm	198	573x1018 mm	2300x1200x350 mm	245
49"	645x1115x100 mm	1095x2263x160 mm	205x205 mm	210	604x1074 mm	2350x1230x350 mm	260
50"	655x1135x100 mm	1095x2263x160 mm	205x205 mm	210	616x1096 mm	2350x1230x350 mm	260
55"	720x1250x100 mm	1174x2400x160 mm	205x205 mm	244	680x1210 mm	2500x1300x350 mm	303
65"	845x1470x100 mm	1296x2617x160 mm	205x205 mm	267	804x1428 mm	2700x1400x350 mm	340
75"	970x1690x100 mm	1424x2650x160 mm	205x205 mm	295	928x1650 mm	2750x1500x350 mm	385

\* Multiple product package sizes may differ from the information written above. Please get information when you order.



# M5D Outdoor Totem Enclosure

Portrait / Double Sided  
43" | 46" | 49" | 50" | 55" | 65" | 75"

cletech



Show this product on the website



## Key Features

- Easy Access for Maintenance
- 8mm Anti-Vandal Tempered Glass
- Available for Floor Mounts
- LED Illuminated Lightbox

## Options

- Tangential Fans for Air Curtain
- UV Protected Foil
- Laminated Anti-Reflective IK10 Glass
- Heaters with Thermostat (optional)

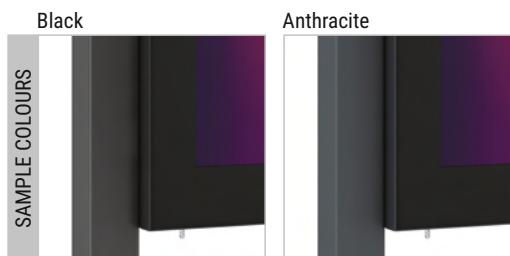

## Main Features

● Included ● Optional ● On Project ● Not Available

Custom Color	Client Logo	Floor Mounts	Base Wheels	Base Feet	Tempered Glass	Lockable Cover	PDU 6 x Socket	Fans for Ventilation	Touch Screen

MONITOR		ENCLOSURE					PACKAGE	
Display (inch)	Mountable Max. Monitor Dimension	Portrait Dimension (WxHxD)	Landscape Dimension (WxHxD)	Feets (WxD)	Weight (kg)	Viewing Area (WxH)	Portrait / Landscape Dimension (WxHxD) (mm)	Weight (kg)
43"	570x980x100 mm	1027x2136x240 mm	1472x1869x240 mm	205x205 mm	156	529x941 mm	2250x1150x350 / 1570x400x1970	206
46"	615x1060x100 mm	1065x2207x240 mm	1549x2082x240 mm	205x205 mm	178	573x1018 mm	2300x1200x350 / 1650x400x2180	228
49"	645x1115x100 mm	1095x2263x240 mm	1605x2113x240 mm	205x205 mm	186	604x1074 mm	2350x1230x350 / 1700x400x2210	240
50"	655x1135x100 mm	1095x2263x240 mm	1605x2113x240 mm	205x205 mm	186	616x1096 mm	2350x1230x350 / 1700x400x2210	240
55"	720x1250x100 mm	1174x2400x240 mm	1742x2148x240 mm	205x205 mm	208	680x1210 mm	2500x1300x350 / 1850x400x2250	268
65"	845x1470x100 mm	1296x2617x240 mm	1866x2180x240 mm	205x205 mm	242	804x1428 mm	2700x1400x350 / 1970x400x2280	305
75"	970x1690x100 mm	1424x2650x300 mm	2185x2288x300 mm	205x205 mm	295	928x1650 mm	2750x1500x350 / 2300x560x2400	385

\* Multiple product package sizes may differ from the information written above. Please get information when you order.



# F9 Outdoor Totem Enclosure

Portrait / Single Sided  
43" | 46" | 49" | 50" | 55" | 65" | 75"

cletech



Show this product on the website



## Key Features

- Easy Access for Maintenance
- 8 mm Anti-Vandal Tempered Glass
- Available for Floor Mounts
- Easy Monitor Mounting
- Heaters with Thermostat

## Options

- Tangential Fans for Air Curtain
- UV Protected Foil
- Laminated Anti-Reflective IK10 Glass

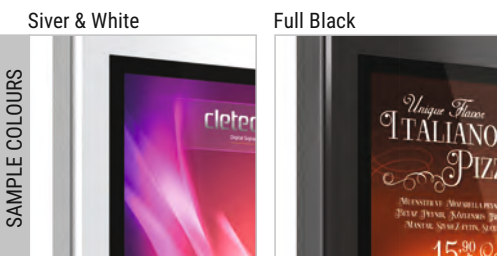

## Main Features

● Included ● Optional ● On Project ● Not Available

Custom Color	Client Logo	Floor Mounts	Base Wheels	Base Feet	Tempered Glass	Lockable Cover	PDU 6 x Socket	Fans for Ventilation	Touch Screen

MONITOR		ENCLOSURE				PACKAGE	
Display (inch)	Mountable Max. Monitor Dimension	Dimension (WxHxD)	Flange (WxD)	Weight (kg)	Viewing Area (WxH)	Dimension (WxHxD)	Weight (kg)
43"	570x980x100 mm	850x2350x151 mm	850x308 mm	124	529x941 mm	2400x950x350 mm	164
46"	615x1060x100 mm	900x2350x151 mm	900x308 mm	142	573x1018 mm	2400x1000x350 mm	187
49"	645x1115x100 mm	935x2350x151 mm	935x308 mm	150	604x1074 mm	2400x1050x350 mm	195
50"	655x1135x100 mm	935x2350x151 mm	935x308 mm	150	616x1096 mm	2400x1050x350 mm	195
55"	720x1250x100 mm	1010x2350x151 mm	1010x308 mm	164	680x1210 mm	2400x1100x350 mm	215
65"	845x1470x100 mm	1220x2350x151 mm	1220x358 mm	195	804x1428 mm	2400x1320x400 mm	260
75"	970x1690x100 mm	1340x2350x151 mm	1340x400 mm	225	928x1650 mm	2400x1500x430 mm	290

\* Multiple product package sizes may differ from the information written above. Please get information when you order.



# FX Outdoor Totem Enclosure

Portrait / Double Sided  
46" | 49" | 50" | 55" | 65" | 75"



Show this product on the website

cletech



## Key Features

- High Quality Finishes
- Easy Access for Maintenance
- 10 mm Anti-Vandal Tempered Glass
- Available for Floor Mounts
- Easy Monitor-TV Mounting

## Options

- Tangential Fans for Air Curtain
- UV Protected Foil
- Laminated Anti-Reflective IK10 Glass
- Heaters with Thermostat
- USB Charging Slots
- Wifi Hotspot Integration
- Bus Stop Integration



## Main Features

● Included    ● Optional    ● On Project    ● Not Available



Custom Color



Client Logo



Floor Mounts



Base Wheels



Base Feet



Tempered Glass



Lockable Cover



PDU Socket  
8 x Socket



Fans for Ventilation



Touch Screen

MONITOR		ENCLOSURE			PACKAGE	
Display (inch)	Mountable Max. Monitor Dimension	Dimension (WxHxD)	Weight (kg)	Viewing Area (WxH)	Dimension (WxHxD)	Weight (kg)
46"	615x1060x100 mm	900x2500x332 mm	280	573x1018 mm	1060x2600x450 mm	345
49"	645x1115x100 mm	945x2600x332 mm	294	604x1074 mm	2700x1110x450 mm	370
50"	655x1135x100 mm	945x2600x332 mm	294	616x1096 mm	2700x1110x450 mm	370
55"	720x1250x100 mm	1006x2800x332 mm	452	680x1210 mm	2900x1160x500 mm	525
65"	845x1470x100 mm	1130x2850x332 mm	530	804x1428 mm	2950x1300x500 mm	600
75"	970x1690x100 mm	1255x2900x332 mm	625	928x1650 mm	3000x1410x500 mm	700

\* Multiple product package sizes may differ from the information written above. Please get information when you order.





Show this product on the website

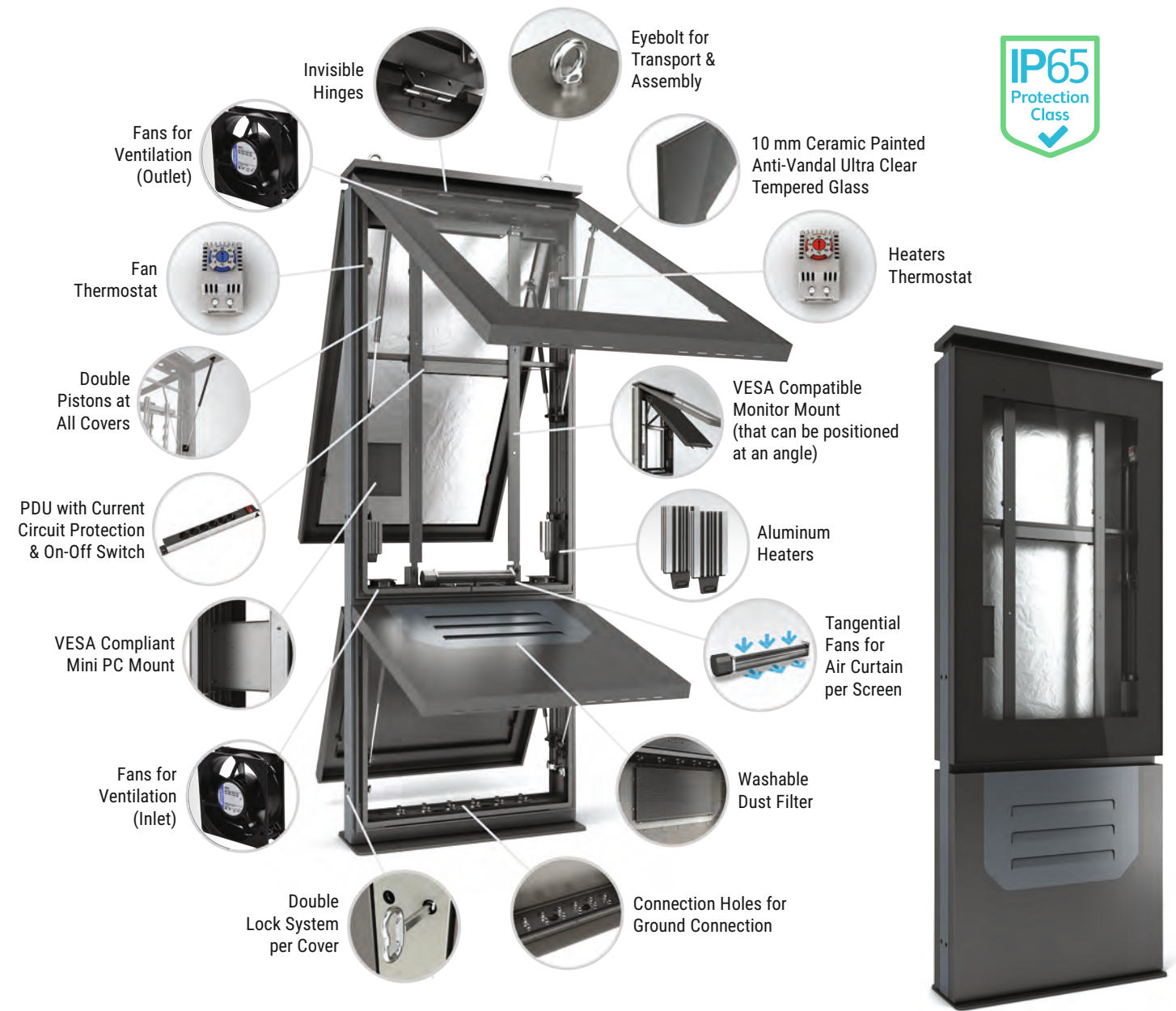

## Key Features

- Easy Access for Maintenance
- 10 mm Anti-Vandal Tempered Glass
- Available for Floor Mounts
- Aluminum & Steel Main Chasis

## Options

- Tangential Fans for Air Curtain
- UV Protected Foil
- Laminated Anti-Reflective IK10 Glass
- Heaters with Thermostat

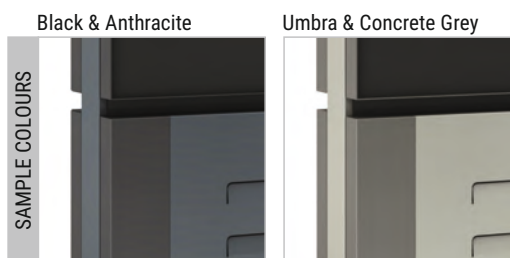

## Main Features

● Included    ● Optional    ● On Project    ● Not Available

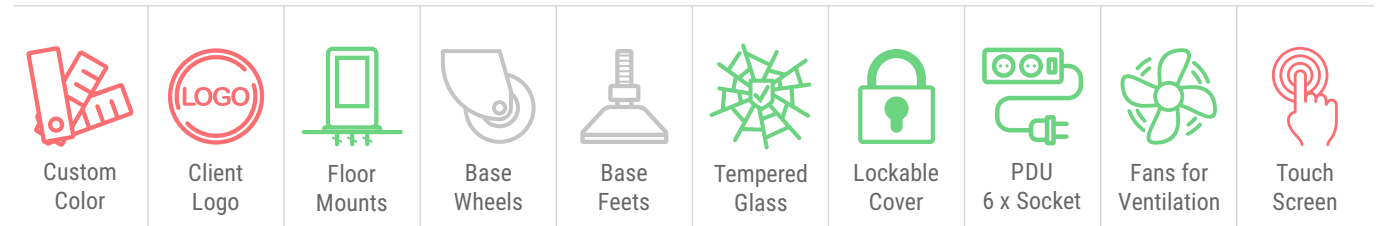

MONITOR		ENCLOSURE				PACKAGE	
Display (inch)	Mountable Max. Monitor Dimension	Dimension (WxHxD)	Flange (WxD)	Weight (kg)	Viewing Area (WxH)	Dimension (WxHxD)	Weight (kg)
46"	615x1060x55 mm	810x2400x212 mm	810x300 mm	228	573x1018 mm	2520x930x400 mm	290
49"	645x1115x55 mm	840x2400x212 mm	840x300 mm	235	604x1074 mm	2520x960x400 mm	300
55"	720x1250x55 mm	915x2500x212 mm	915x300 mm	262	680x1210 mm	2620x1040x400 mm	335
65"	845x1470x100 mm	1040x2650x300 mm	1040x400 mm	310	804x1428 mm	2730x1160x500 mm	385
75"	970x1690x100 mm	1165x2800x300 mm	1165x400 mm	335	928x1650 mm	2900x1290x500 mm	415

\* Multiple product package sizes may differ from the information written above. Please get information when you order.



# RD Outdoor Totem Enclosure

Portrait / Double Sided  
46" | 49" | 55" | 65" | 75"



Show this product on the website

cletech

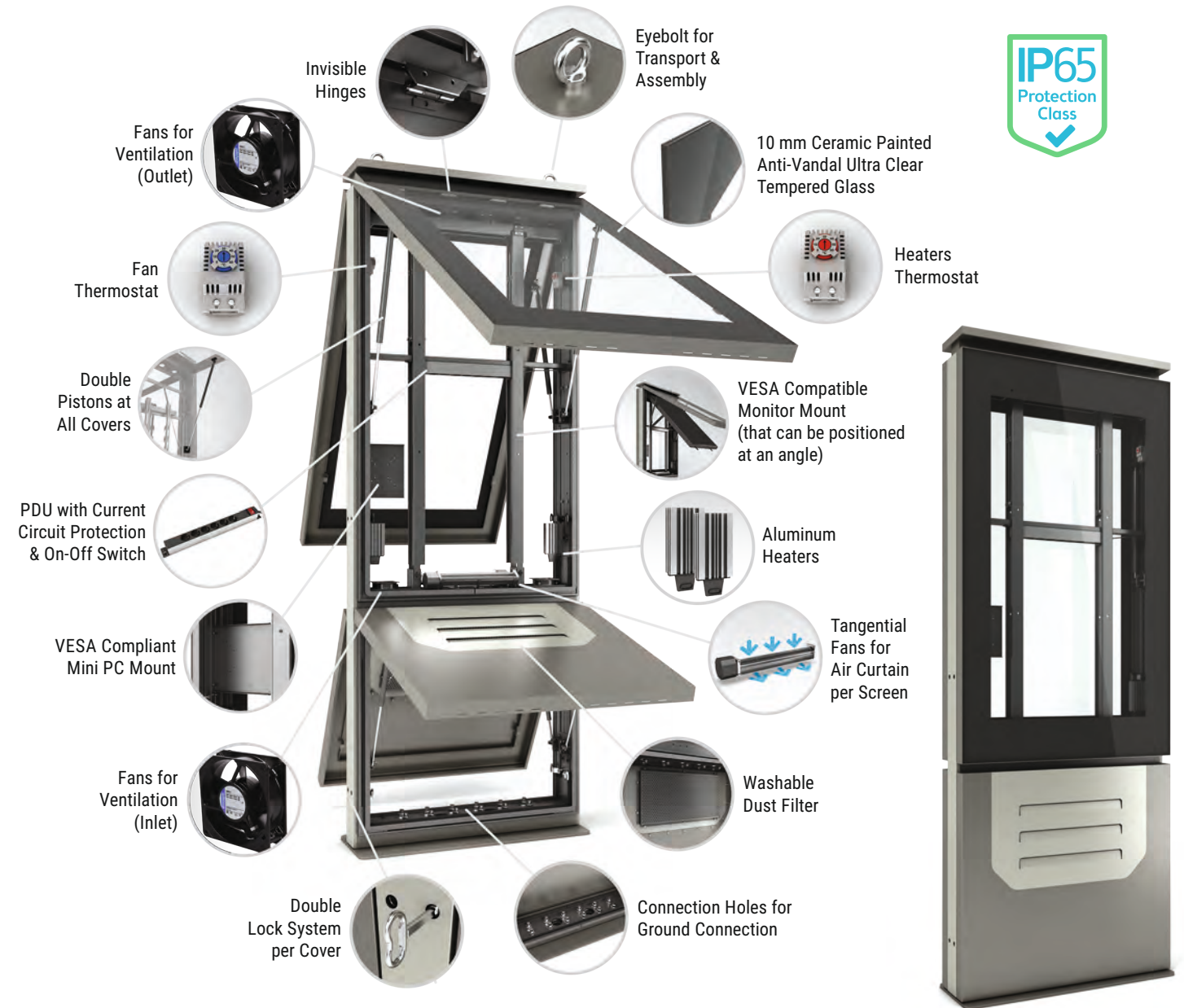

## Key Features

- Easy Access for Maintenance
- 10 mm Anti-Vandal Tempered Glass
- Available for Floor Mounts
- Aluminum & Steel Main Chasis

## Options

- Tangential Fans for Air Curtain
- UV Protected Foil
- Laminated Anti-Reflective IK10 Glass
- Heaters with Thermostat



Umbr & Concrete Grey

Black & Anthracite



## Main Features

● Included ● Optional ● On Project ● Not Available

Custom Color	Client Logo	Floor Mounts	Base Wheels	Base Feet	Tempered Glass	Lockable Cover	PDU 6 x Socket	Fans for Ventilation	Touch Screen

MONITOR		ENCLOSURE				PACKAGE	
Display (inch)	Mountable Max. Monitor Dimension	Dimension (WxHxD)	Flange (WxD)	Weight (kg)	Viewing Area (WxH)	Dimension (WxHxD)	Weight (kg)
46"	615x1060x55 mm	810x2400x212 mm	810x300 mm	238	573x1018 mm	2520x930x400 mm	300
49"	645x1115x55 mm	840x2400x212 mm	840x300 mm	245	604x1074 mm	2520x960x400 mm	310
55"	720x1250x55 mm	915x2500x212 mm	915x300 mm	276	680x1210 mm	2620x1040x400 mm	350
65"	845x1470x100 mm	1040x2650x300 mm	1040x400 mm	325	804x1428 mm	2730x1160x500 mm	400
75"	970x1690x100 mm	1165x2800x300 mm	1165x400 mm	360	928x1650 mm	2900x1290x500 mm	440

\* Multiple product package sizes may differ from the information written above. Please get information when you order.





Show this product on the website

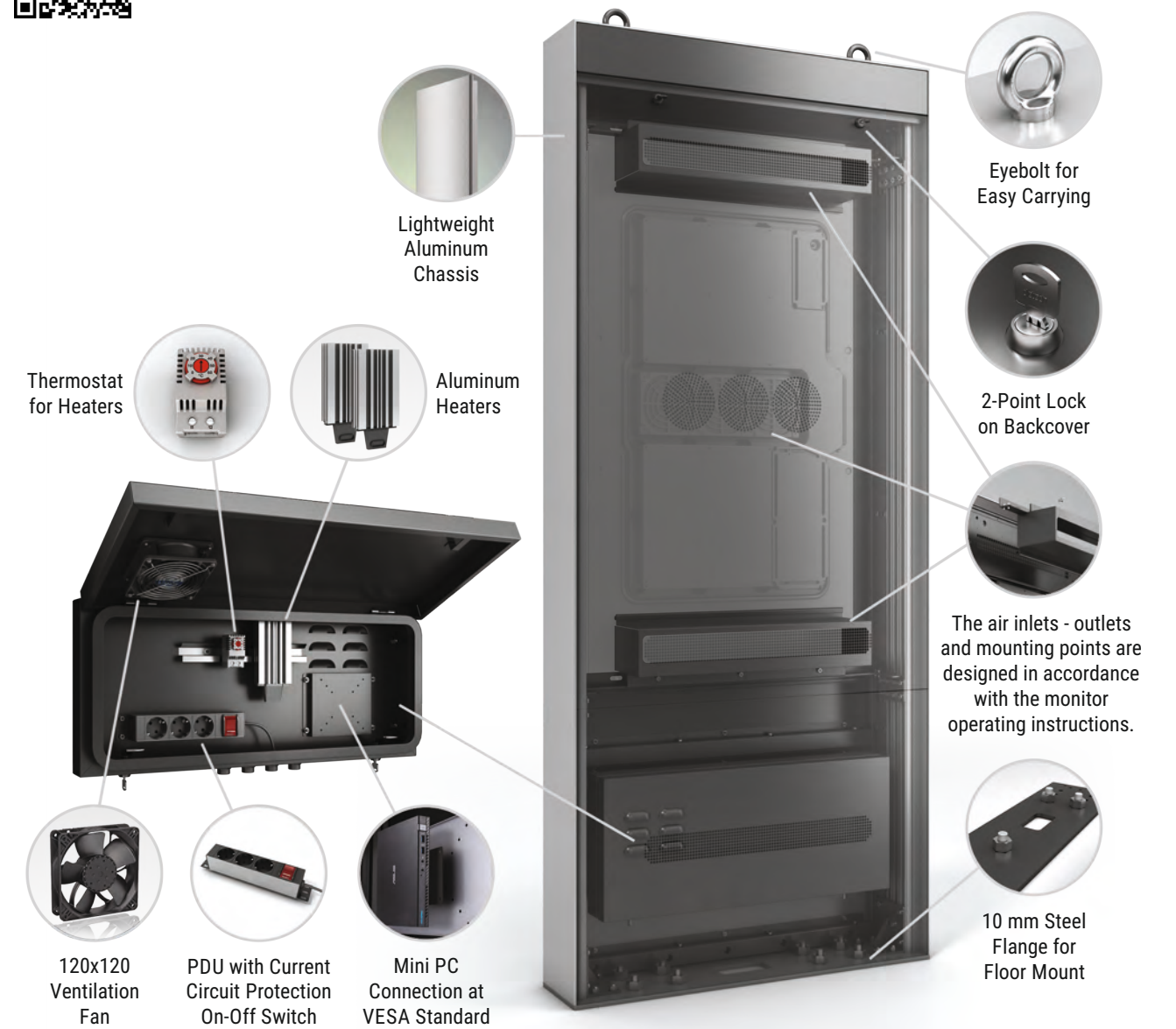

**Key Features**

- High Quality Finishes
- IP56 Rated Box for Media Player-PC
- Compatible for Full Outdoor Monitors
- Available for Floor Mounts
- Easy Monitor Mounting
- Aluminum Main Chassis



Colour Code: BBB

Colour Code: ABB



\* Shown product is compatible with Samsung OHF and OHA series. Please contact for images and drawings suitable for other full outdoor models of Samsung and LG.

**Main Features**

● Included ● Optional ● On Project ● Not Available

Custom Color	Client Logo	Floor Mounts	Base Wheels	Base Feet	Tempered Glass	Lockable Cover	PDU 3 x Socket	Fans for Ventilation	Touch Screen

MONITOR		ENCLOSURE				PACKAGE	
Display (inch)	Mountable Max. Monitor Dimension	Portrait Dimension (WxHxD)	Landscape Dimension (WxHxD)	Weight (kg)	Viewing Area (WxH)	Portrait / Landscape Dimension (WxHxD) (mm)	Weight (kg)
46"	630x1100x130 mm	756x2023x190 mm	1318x1800x190 mm	93	573x1018 mm	2080x820x250 / 1380x1860x250	98
49"	660x1200x130 mm	787x2023x190 mm	1374x1800x190 mm	98	604x1074 mm	2080x850x250 / 1430x1860x250	103
55"	740x1300x130 mm	863x2023x190 mm	1510x1800x190 mm	105	680x1210 mm	2080x920x250 / 1570x1860x250	110
75"	1060x1800x130 mm	1111x2350x190 mm	1950x1950x190 mm	130	928x1650 mm	2410x1160x250 / 2010x2010x250	136
85"	1200x2050x130 mm	1236x2550x190 mm	2175x2000x190 mm	165	1053x1872 mm	2610x1300x250 / 2240x2060x250	172

\* Multiple product package sizes may differ from the information written above. Please get information when you order.





Show this product on the website

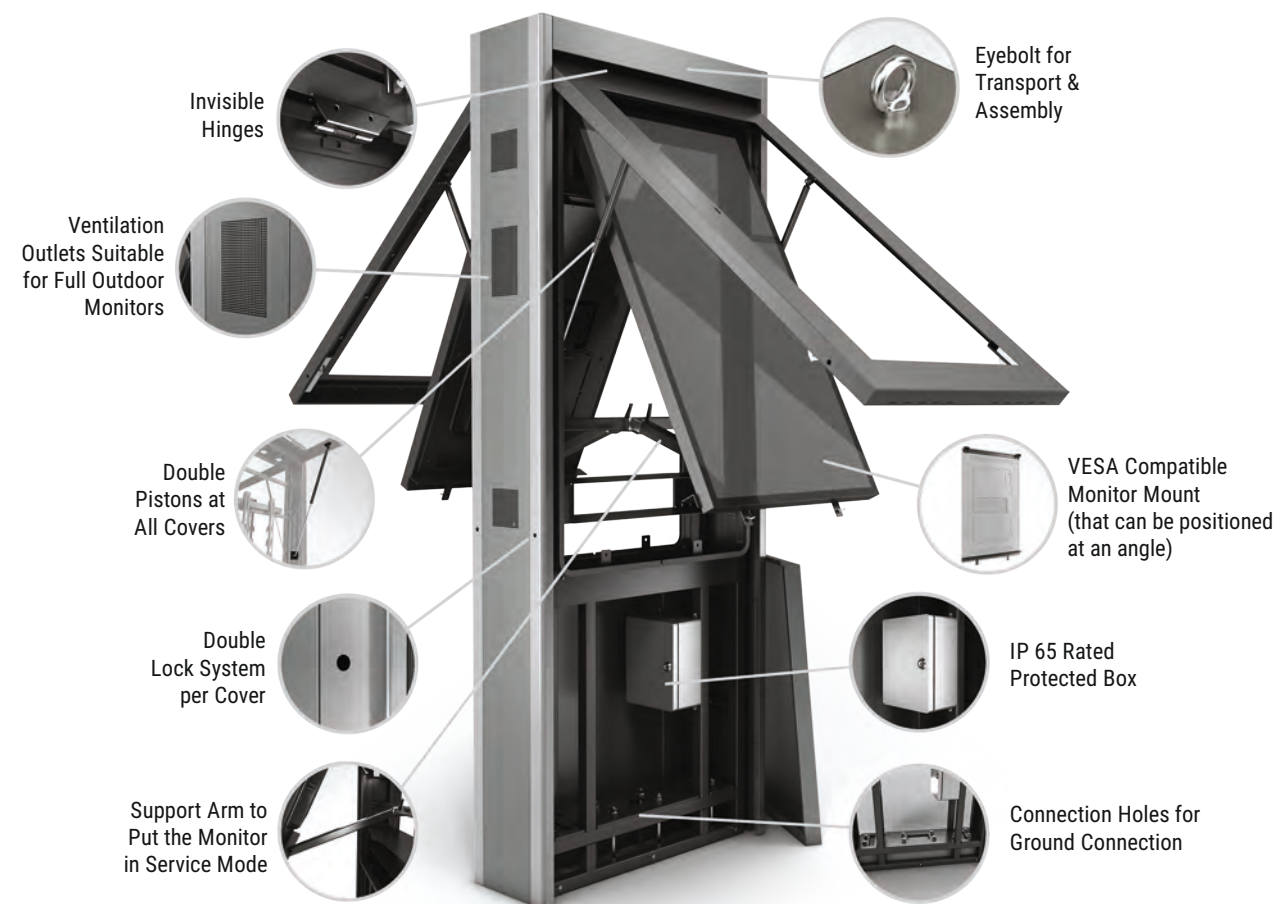

**Key Features**

- High Quality Finishes
- IP65 Rated Box
- Compatible for Full Outdoor Monitors
- Available for Floor Mounts
- Easy Monitor Mounting
- Steel Main Chassis



Introducing Cletech WX Double-Sided Totem, meticulously designed for full outdoor monitors. This cutting-edge totem is fully compatible with Samsung and LG Full Outdoor monitors, ensuring seamless integration into your outdoor display setup. Engineered with ventilation inlets and outlets aligned with the technical specifications of these renowned brands, Cletech WX guarantees optimal performance in any outdoor environment.

\* Shown product is compatible with Samsung OHF and OHA series. Please contact for images and drawings suitable for other full outdoor models of Samsung and LG.

**Main Features**

● Included ● Optional ● On Project ● Not Available

Custom Color	Client Logo	Floor Mounts	Base Wheels	Base Feet	Tempered Glass	Lockable Cover	PDU 3 x Socket	Fans for Ventilation	Touch Screen

MONITOR		ENCLOSURE			PACKAGE	
Display (inch)	Mountable Max. Monitor Dimension	Dimension (WxHxD) mm	Weight (kg)	Viewing Area (WxH) mm	Dimension (WxHxD) mm	Weight (kg)
46"	624x1069x85 mm	855x2395x324 mm	215	573x1018 mm	2480x980x400 mm	275
49"	656x1153x88 mm	900x2395x324 mm	225	604x1074 mm	2480x1020x400 mm	300
55"	732x1261x84 mm	978x2495x324 mm	247	680x1210 mm	2580x1100x400 mm	325
75"	1054x1775x130 mm	1300x2695x410 mm	325	928x1650 mm	2780x1420x500 mm	400

\* Multiple product package sizes may differ from the information written above. Please get information when you order.



# T1 Totem Enclosure for Full Outdoor Monitors

Portrait / Single Sided  
46" | 49" | 55" | 75"



Show this product on the website

DRIVE THRU COLLECTIONS

cletech



Introducing the Cletech T1, the cutting-edge solution tailored for Full Outdoor Monitors from Samsung and LG. Boasting a two-way service feature, the Cletech T1 enhances user convenience by facilitating efficient communication and maintenance between the monitor and external devices. With air directions and outlets meticulously aligned according to the brands' instructions, the Cletech T1 optimizes airflow, promoting effective cooling.

Its user-friendly design makes the process straightforward, allowing users to set up and start enjoying outdoor monitor experiences quickly. Crafted from robust steel material, the Cletech T1 is built to withstand challenging outdoor conditions. Additionally, it is coated with primers and paints specially formulated for outdoor use, providing durability and protection against the elements.

## Key Features

- High Quality Finishes
- Double Side Access for Maintenance
- Available for Floor Mounts
- Easy Monitor-TV Mounting
- Steel Main Chasis
- Lockable Back Cover



## Main Features

● Included ● Optional ● On Project ● Not Available

Custom Color	Client Logo	Floor Mounts	Base Wheels	Base Feet	Tempered Glass	Lockable Cover	PDU 3 x Socket	Fans for Ventilation	Touch Screen

MONITOR		ENCLOSURE			PACKAGE	
Display (inch)	Mountable Max. Monitor Dimension	Dimension (WxHxD)	Flange (WxD)	Weight (kg)	Dimension (WxHxD)	Weight (kg)
46"	624x1069x85 mm	726x2120x100 mm	726x200 mm	92	2180x790x140 mm	102
49"	656x1153x88 mm	758x2120x100 mm	758x200 mm	96	2180x820x140 mm	106
55"	732x1261x84 mm	834x2220x100 mm	834x200 mm	103	2280x900x140 mm	113
75"	1054x1775x130 mm	1160x2620x150 mm	1160x300 mm	145	2680x1220x200 mm	160

\* Multiple product package sizes may differ from the information written above. Please get information when you order.





Show this product on the website



We manufacture enclosures compatible with Samsung and LG brand full outdoor monitors in sizes ranging from 46" to 75". Our enclosures come in single, double, and triple versions to accommodate various setups. They are meticulously designed to meet all the ventilation and connection requirements specified by the monitor manufacturers. Crafted entirely from steel, our enclosures prioritize durability and robustness.

**Key Features**

- High Quality Finishes
- Easy Access for Maintenance
- Available for Floor Mounts
- Easy Monitor-TV Mounting
- Comply with Manufacturers' Instructions



**Main Features**

● Included    ● Optional    ● On Project    ● Not Available

Custom Color	Client Logo	Floor Mounts	Base Wheels	Base Feet	Tempered Glass	Lockable Cover	IP65 Junction Box	Fans for Ventilation	Touch Screen

MONITOR		ENCLOSURE			PACKAGE	
Display (inch)	Monitor Model	Dimension without Flange (WxHxD)	Flange (WxD)	Weight (kg)	Dimension (WxHxD)	Weight (kg)
46"	Samsung OH46	670x1703x136 mm	410x335 mm	77	700x1950x400 mm	86
49"	LG 49XE	750x1787x136 mm	410x335 mm	78	780x2000x400 mm	87
55"	Samsung OH55	778x1894x136 mm	410x335 mm	81	800x2110x400 mm	90
55"	LG 55XE	784x1927x136 mm	410x335 mm	81	820x2140x400 mm	90
75"	Samsung OH75	1106x2341x160 mm	550x400 mm	125	1130x2460x500 mm	137



# DT2 Outdoor Totem Enclosure for Full Outdoor Monitors

Portrait / Single Sided  
46" | 49" | 55"



Show this product on the website

**DRIVE THRU**  
COLLECTIONS

**cletech**



Compatible for Samsung & LG Full Outdoor Monitors (Shown Samsung OH55A)

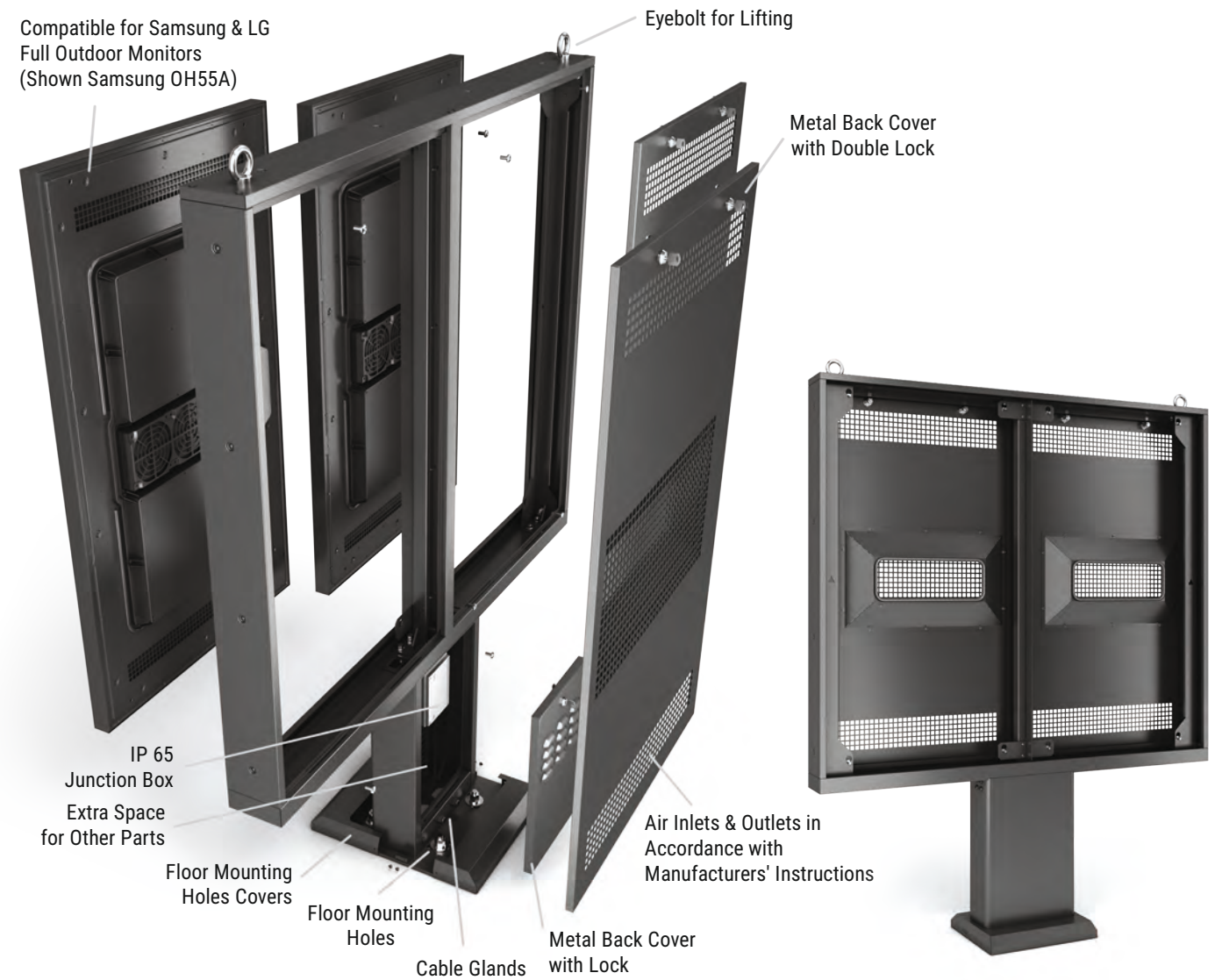

We manufacture enclosures compatible with Samsung and LG brand full outdoor monitors in sizes ranging from 46" to 75". Our enclosures come in single, double, and triple versions to accommodate various setups. They are meticulously designed to meet all the ventilation and connection requirements specified by the monitor manufacturers. Crafted entirely from steel, our enclosures prioritize durability and robustness.

## Key Features

- High Quality Finishes
- Easy Access for Maintenance
- Available for Floor Mounts
- Easy Monitor-TV Mounting
- Comply with Manufacturers' Instructions



## Main Features

● Included ● Optional ● On Project ● Not Available



Custom Color



Client Logo



Floor Mounts



Base Wheels

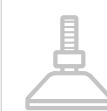

Base Feet



Tempered Glass



Lockable Cover

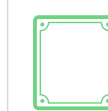

IP65 Junction Box



Fans for Ventilation



Touch Screen

MONITOR		ENCLOSURE			PACKAGE	
Display (inch)	Monitor Model	Dimension without Flange (WxHxD)	Flange (WxD)	Weight (kg)	Dimension (WxHxD)	Weight (kg)
46"	Samsung OH46	1293x1703x136 mm	410x335 mm	92	1330x1950x400 mm	105
49"	LG 49XE	1406x1787x136 mm	410x335 mm	95	1440x2000x400 mm	108
55"	Samsung OH55	1511x1894x136 mm	410x335 mm	110	1540x2110x400 mm	123
55"	LG 55XE	1517x1927x136 mm	410x335 mm	110	1540x2140x400 mm	123



# DT3 Outdoor Totem Enclosure for Full Outdoor Monitors

Portrait / Single Sided  
46" | 49" | 55"



Show this product on the website

**DRIVE THRU**  
COLLECTIONS

**cletech**

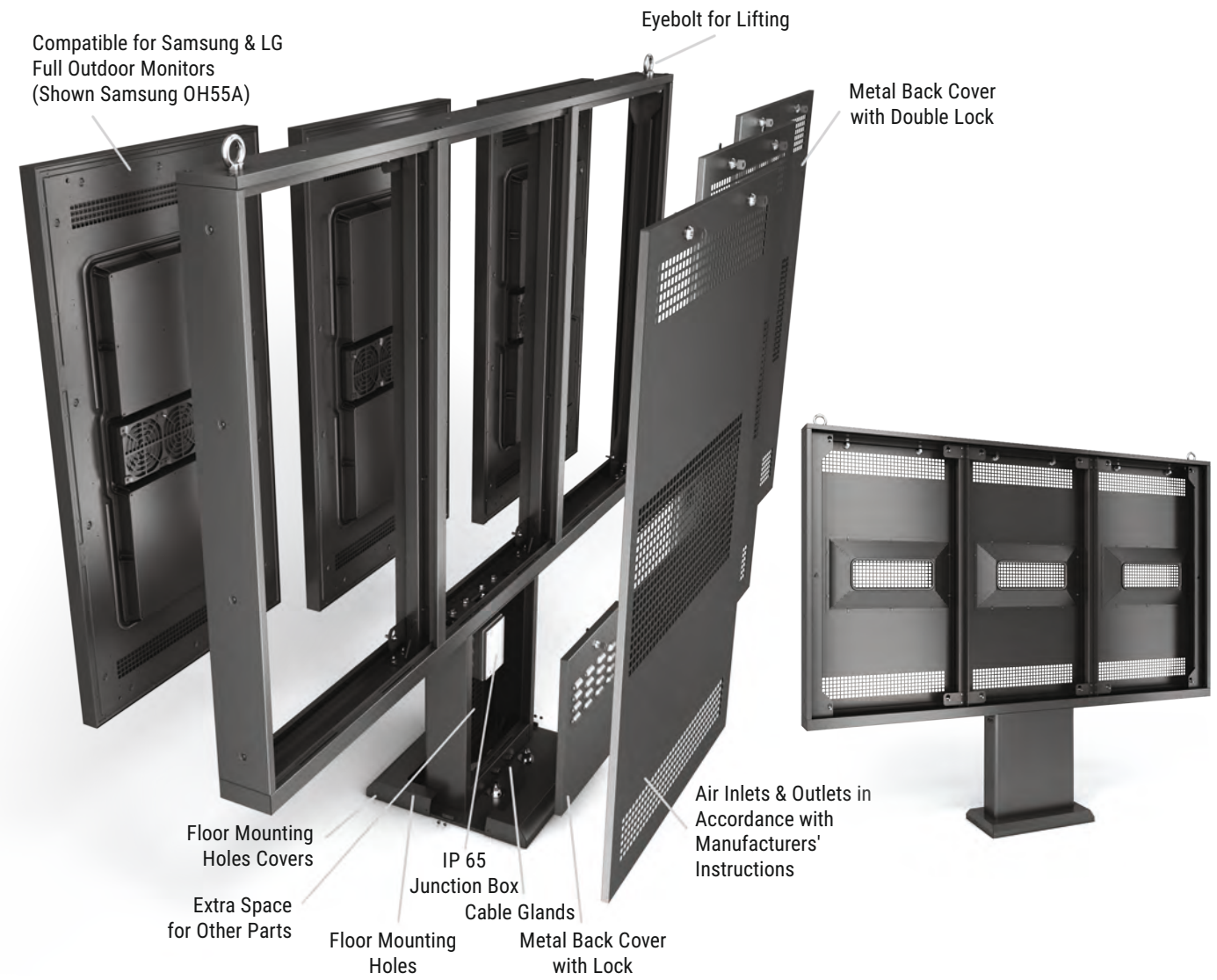

## Key Features

- High Quality Finishes
- Easy Access for Maintenance
- Available for Floor Mounts
- Easy Monitor-TV Mounting
- Comply with Manufacturers' Instructions



## Main Features

● Included ● Optional ● On Project ● Not Available



Custom Color



Client Logo



Floor Mounts



Base Wheels



Base Feets



Tempered Glass



Lockable Cover

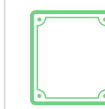

IP65 Junction Box



Fans for Ventilation



Touch Screen

MONITOR		ENCLOSURE			PACKAGE	
Display (inch)	Monitor Model	Dimension without Flange (WxHxD)	Flange (WxD)	Weight (kg)	Dimension (WxHxD)	Weight (kg)
46"	Samsung OH46	1920x1703x136 mm	565x335 mm	110	1950x1950x400 mm	135
49"	LG 49XE	2065x1787x136 mm	565x335 mm	115	2090x2000x400 mm	145
55"	Samsung OH55	2243x1894x136 mm	565x335 mm	145	2270x2110x400 mm	176
55"	LG 55XE	2257x1927x136 mm	565x335 mm	145	2280x2140x400 mm	176





The K Series Outdoor Self-Order Kiosk is specifically designed for outdoor monitors. It is fully compatible with monitors such as the Elo Touch 2799L 27" and LG 22XF1TJ-B 21.5". With various stand options, it can be installed solely on the floor, on both the floor and ceiling, or mounted on a wall, offering both single-sided and double-sided usage options.

**Key Features**

- Easy Access for Maintenance
- Compatible for Full Outdoor Monitors
- Available Floor Mounts
- Customize for POS Devices
- IP56 Protection Rating
- Version KSO : Outdoor Single-Sided
- Version KDO : Outdoor Double-Sided
- Version KWO : Outdoor Wall Mount



Show this product on the website



**Main Features**

● Included ● Optional ● On Project ● Not Available

Custom Color	Client Logo	Floor Mounts	Base Wheels	Base Feet	Tempered Glass	Lockable Cover	PDU 6 x Socket	Fans for Ventilation	Touch Screen

MONITOR	ENCLOSURE				PACKAGE		
Display (inch)	Dimension without Stand (WxHxD)	Dimension with Stand (WxHxD)	Weight without Stand	Weight with Stand	Viewing Area (WxH)	Dimension (WxHxD)	Weight (kg)
22"	450x1050x250 mm	450x1850x250 mm	41 kg	58 kg	268x476 mm	1890x490x290 mm	62
27"	525x1100x250 mm	525x1917x250 mm	44 kg	61 kg	336x598 mm	1980x570x290 mm	65
32"	560x1150x250 mm	560x1917x250 mm	46 kg	63 kg	392x697 mm	1980x600x290 mm	67

\* Multiple product package sizes may differ from the information written above. Please get information when you order.  
\* Weights are given excluding electronic equipment.





The Cetech L1 Outdoor Totem Enclosure is a durable and versatile solution for outdoor use. It is available in single-sided or double-sided configurations, with an IP65 protection rating for all-weather resistance. Equipped with air intake and exhaust fans, an air curtain, and an anti-vandal design, it ensures security and efficient ventilation. The enclosure comes standard with IK8 glass, with an optional IK10 anti-reflective glass upgrade, and operates reliably 24/7/365. It supports P 1.9 and P 2.5 LED panels or can be customized for specific panel requirements.

### Key Features

- Side-opening Covers
- Vandal-proof Enclosure Design
- Easy Access for Maintenance
- IP65 Protection Class
- IK10 Class Anti-Reflective Safety Glass (Optional)
- Enclosure Management System (Optional)

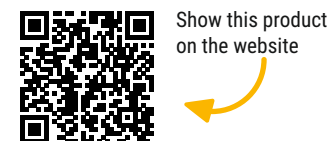

### Cletech Enclosure Management System

The optional Enclosure Management System enables remote monitoring of temperature, humidity, shock, ambient light, and motion, while also managing fan operation, filter dust levels, and door status. Combining innovative features with robust performance, it is an ideal choice for outdoor digital display needs.

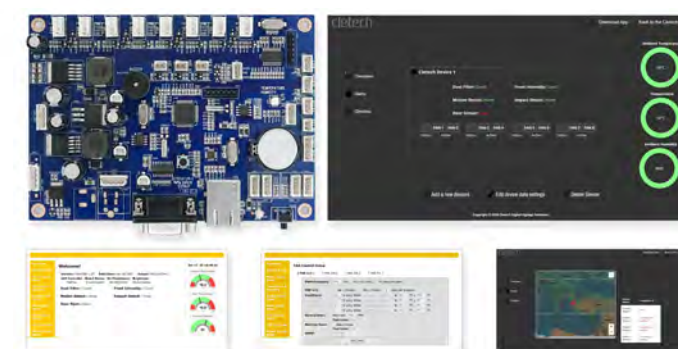

### Main Features

● Included ● Optional ● On Project ● Not Available

Custom Color	Client Logo	Floor Mounts	Base Wheels	Base Feet	Tempered Glass	Lockable Cover	PDU 8 x Socket	Fans for Ventilation	Touch Screen

Model Code	MONITOR		ENCLOSURE				PACKAGE	
	Display (inch)	Display (cm)	Dimension from Floor (WxHxD) mm	Full Size Dimension (WxHxD) mm	Weight (kg)	Viewing Area (WxH) mm	Dimension (WxHxD) mm	Weight (kg)
L1S	79" Single	100x175 cm	1230x2474x312 mm	1230x2530x312 mm	360	1000x1750 mm	1290x2670x500 mm	504
L1D	79" Double	100x175 cm	1230x2474x312 mm	1230x2530x312 mm	424	1000x1750 mm	1290x2670x500 mm	568



# Mounting Solutions





**ST1L-A**  
Single Light Pole Floor Stand  
from 32" up to 55" with Fix Arms

**SPECIFICATIONS & OPTIONS**

Reference Code	ST1L-A
Product Code	ST1L-A380-LP160-FA300
Available Screen Size	32" ~ 55"
VESA Pattern	Min 100x100, Max 300x300
Maximum Load	30 kg.
Fix Arms	Yes
Tilt Arms	Optional
Micro Adjustable Arms	No
Material	Steel, Aluminum, Plastic
Surface Finishing	Electrostatic Powder Coating
Colour Options	Black, Silver, White
Product Dimension	796x529x1649 mm (WxDxH)
Product Weight	31 kg.
Adjustable Base Feet	Standard
Wheel Kit	WK50 (Optional)
Cam Holder	CH01 (Optional)
Shelf	SH01 (Optional)
PDU	PDU3S (Optional)



**ST1LD-B**  
Double Light Pole Floor Stand  
from 55" up to 88" with Fix Arms

**SPECIFICATIONS & OPTIONS**

Reference Code	ST1LD-B
Product Code	ST1LD-B980-LP180-FA600
Available Screen Size	55" ~ 88"
VESA Pattern	Min 100x100, Max 900x600
Maximum Load	60 kg.
Fix Arms	Yes
Tilt Arms	Optional
Micro Adjustable Arms	Optional
Material	Steel, Aluminum, Plastic
Surface Finishing	Electrostatic Powder Coating
Colour Options	Black, Silver, White
Product Dimension	988x529x1894 mm (WxDxH)
Product Weight	55 kg.
Adjustable Base Feet	Standard
Wheel Kit	WK75 (Optional)
Cam Holder	CH01 (Optional)
Shelf	SH02 (Optional)
PDU	PDU3S (Optional)



**ST1L-B**  
Single Light Pole Floor Stand  
from 32" up to 65" with Fix Arms

**SPECIFICATIONS & OPTIONS**

Reference Code	ST1L-B
Product Code	ST1L-B480-LP160-FA400
Available Screen Size	32" ~ 65"
VESA Pattern	Min 100x100, Max 600x400
Maximum Load	40 kg.
Fix Arms	Yes
Tilt Arms	Optional
Micro Adjustable Arms	Optional
Material	Steel, Aluminum, Plastic
Surface Finishing	Electrostatic Powder Coating
Colour Options	Black, Silver, White
Product Dimension	796x529x1649 mm (WxDxH)
Product Weight	29 kg.
Adjustable Base Feet	Standard
Wheel Kit	WK50 (Optional)
Cam Holder	CH01 (Optional)
Shelf	SH01 (Optional)
PDU	PDU3S (Optional)



**ST1S-B**  
Single Strong Pole Floor Stand  
from 50" up to 75" with Fix Arms

**SPECIFICATIONS & OPTIONS**

Reference Code	ST1S-B
Product Code	ST1S-B480-SP160-FA400
Available Screen Size	50" ~ 75"
VESA Pattern	Min 100x100, Max 600x600
Maximum Load	60 kg.
Fix Arms	Yes
Tilt Arms	Optional
Micro Adjustable Arms	Optional
Material	Steel, Aluminum, Plastic
Surface Finishing	Electrostatic Powder Coating
Colour Options	Black, Silver, White
Product Dimension	796x529x1749 mm (WxDxH)
Product Weight	37 kg.
Adjustable Base Feet	Standard
Wheel Kit	WK75 (Optional)
Cam Holder	CH01 (Optional)
Shelf	SH02 (Optional)
PDU	PDU3S (Optional)





**ST2L-A**  
Single Light Pole Trolley  
from 40" up to 65" with Fix Arms

**SPECIFICATIONS & OPTIONS**

Reference Code	ST2L-A
Product Code	ST2L-A480-LP150-FA400
Available Screen Size	40" ~ 65"
VESA Pattern	Min 100x100, Max 600x400
Maximum Load	35 kg.
Fix Arms	Yes
Tilt Arms	Optional
Micro Adjustable Arms	No
Material	Steel, Aluminum, Plastic
Surface Finishing	Electrostatic Powder Coating
Colour Options	Black, Silver, White
Product Dimension	901x648x1600 mm (WxDxH)
Product Weight	18 kg.
Adjustable Base Feet	BF50 (Optional)
Wheel Kit	WK50 (Standard)
Cam Holder	CH01 (Optional)
Shelf	SH02 (Optional)
PDU	PDU3S (Optional)



**ST2LD-B**  
Double Light Pole Trolley  
from 55" up to 88" with Fix Arms

**SPECIFICATIONS & OPTIONS**

Reference Code	ST1LD-B
Product Code	ST2LD-B880-LP180-FA600
Available Screen Size	55" ~ 88"
VESA Pattern	Min 100x100, Max 800x800
Maximum Load	50 kg.
Fix Arms	Yes
Tilt Arms	Optional
Micro Adjustable Arms	Optional
Material	Steel, Aluminum, Plastic
Surface Finishing	Electrostatic Powder Coating
Colour Options	Black, Silver, White
Product Dimension	1237x851x1925 mm (WxDxH)
Product Weight	21 kg.
Adjustable Base Feet	BF50 (Optional)
Wheel Kit	WK75 (Standard)
Cam Holder	CH01 (Optional)
Shelf	SH02, SH03 (Optional)
PDU	PDU3S (Optional)



**ST2L-B**  
Single Light Pole Trolley  
from 40" up to 65" with Fix Arms

**SPECIFICATIONS & OPTIONS**

Reference Code	ST2L-B
Product Code	ST2L-B480-LP150-TA400
Available Screen Size	40" ~ 65"
VESA Pattern	Min 100x100, Max 600x400
Maximum Load	40 kg.
Fix Arms	Optional
Tilt Arms	Yes
Micro Adjustable Arms	Optional
Material	Steel, Aluminum, Plastic
Surface Finishing	Electrostatic Powder Coating
Colour Options	Black, Silver, White
Product Dimension	901x648x1600 mm (WxDxH)
Product Weight	28 kg.
Adjustable Base Feet	BF50 (Optional)
Wheel Kit	WK50 (Standard)
Cam Holder	CH01 (Optional)
Shelf	SH02 (Optional)
PDU	PDU3S (Optional)



**ST2S-B**  
Single Strong Pole Trolley  
from 50" up to 75" with Fix Arms

**SPECIFICATIONS & OPTIONS**

Reference Code	ST2S-B
Product Code	ST2S-B680-SP170-TA400
Available Screen Size	50" ~ 75"
VESA Pattern	Min 100x100, Max 600x400
Maximum Load	50 kg.
Fix Arms	Yes
Tilt Arms	Optional
Micro Adjustable Arms	Optional
Material	Steel, Aluminum, Plastic
Surface Finishing	Electrostatic Powder Coating
Colour Options	Black, Silver, White
Product Dimension	1001x699x1827 mm (WxDxH)
Product Weight	21 kg.
Adjustable Base Feet	BF50 (Optional)
Wheel Kit	WK75 (Standard)
Cam Holder	CH01 (Optional)
Shelf	SH02 (Optional)
PDU	PDU3S (Optional)





## ST3L-BD

### Single Light Pole Trolley

from 40" up to 65" with Fix Arms  
Back to Back

#### SPECIFICATIONS & OPTIONS

Reference Code	ST3L-BD
Product Code	ST3L-B480D-LP150-FA300
Available Screen Size	40" ~ 65"
VESA Pattern	Min 100x100, Max 400x300
Maximum Load	30 kg. per screen
Fix Arms	Yes
Tilt Arms	Optional
Micro Adjustable Arms	Optional
Material	Steel, Aluminum, Plastic
Surface Finishing	Electrostatic Powder Coating
Colour Options	Black, Silver, White
Product Dimension	885x672x1698 mm (WxDxH)
Product Weight	27 kg.
Adjustable Base Feet	BF50 (Optional)
Wheel Kit	WK50 (Standard)
Cam Holder	CH01 (Optional)
Shelf	Sh03 (Optional)
PDU	PDU3S (Optional)



## ST3S-BD

### Single Strong Pole Trolley

from 40" up to 65" with Fix Arms  
Back to Back

#### SPECIFICATIONS & OPTIONS

Reference Code	ST3S-BD
Product Code	ST3S-B480D-SP150D-FA400
Available Screen Size	40" ~ 65"
VESA Pattern	Min 100x100, Max 800x600
Maximum Load	35 kg. per screen
Fix Arms	Yes
Tilt Arms	Optional
Micro Adjustable Arms	Optional
Material	Steel, Aluminum, Plastic
Surface Finishing	Electrostatic Powder Coating
Colour Options	Black, Silver, White
Product Dimension	885x722x1698 mm (WxDxH)
Product Weight	34 kg.
Adjustable Base Feet	BF50 (Optional)
Wheel Kit	WK75 (Standard)
Cam Holder	CH01 (Optional)
Shelf	SH03 (Optional)
PDU	PDU3S (Optional)



## ST3LD-BD

### Double Light Pole Trolley

from 55" up to 88" with Fix Arms  
Back to Back

#### SPECIFICATIONS & OPTIONS

Reference Code	ST3LD-BD
Product Code	ST3LD-B880D-LP150D-FA600
Available Screen Size	55" ~ 88"
VESA Pattern	Min 100x100, Max 800x600
Maximum Load	40 kg. per screen
Fix Arms	Yes
Tilt Arms	Optional
Micro Adjustable Arms	Yes
Material	Steel, Aluminum, Plastic
Surface Finishing	Electrostatic Powder Coating
Colour Options	Black, Silver, White
Product Dimension	885x672x1698 mm (WxDxH)
Product Weight	39 kg.
Adjustable Base Feet	Bf50 (Optional)
Wheel Kit	WK50 (Standard)
Cam Holder	CH01 (Optional)
Shelf	SH03, SH04 (Optional)
PDU	PDU3S (Optional)



## ST3SD-BD

### Double Strong Pole Trolley

from 55" up to 98" with Fix Arms  
Back to Back

#### SPECIFICATIONS & OPTIONS

Reference Code	ST3SD-BD
Product Code	ST3S-B880D-SP180D-FA900
Available Screen Size	55" ~ 98"
VESA Pattern	Min 100x100, Max 1200x900
Maximum Load	600 kg. per screen
Fix Arms	Yes
Tilt Arms	Optional
Micro Adjustable Arms	Optional
Material	Steel, Aluminum, Plastic
Surface Finishing	Electrostatic Powder Coating
Colour Options	Black, Silver, White
Product Dimension	1001x699x1827 mm (WxDxH)
Product Weight	46 kg.
Adjustable Base Feet	BF50 (Optional)
Wheel Kit	WK75 (Standard)
Cam Holder	CH01 (Optional)
Shelf	SH03, SH04 (Optional)
PDU	PDU3S (Optional)

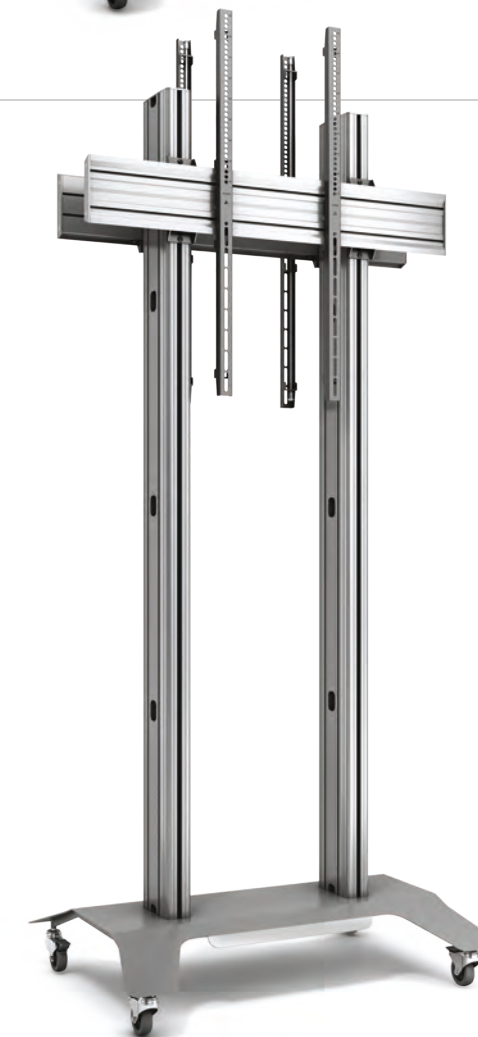



## ST2LD with ROT400 Double Light Pole Trolley from 55" up to 75" with Rotate & Tilt-up Arms

### SPECIFICATIONS & OPTIONS

Reference Code	ST1LD
Product Code	ST2LD-LP170D-ROT400
Available Screen Size	55" ~ 75"
VESA Pattern	Min 200x200, Max 400x400
Maximum Load	50 kg.
Fix Arms	No
Tilt Arms	Yes (rotate & only tilt-up)
Micro Adjustable Arms	No
Material	Steel, Aluminum, Plastic
Surface Finishing	Electrostatic Powder Coating
Colour Options	Black, Silver, White
Product Dimension	1237x851x1925 mm (WxDxH)
Product Weight	27 kg.
Adjustable Base Feet	BF50 (Optional)
Wheel Kit	WK75 (Standard)
Cam Holder	CH01 (Optional)
Shelf	SH02, SH03 (Optional)
PDU	PDU3S (Optional)



Cable Management System



±90°

### Flip, Tilt, Roll: Your Monitor, Your Way

Cletech Rotational Stand offers versatile compatibility, accommodating monitors ranging from 55" to 75". Specifically tailored for Samsung Flip Series products, this stand allows you to seamlessly switch between vertical and horizontal orientations. The 5-degree tilt-up feature enhances viewing flexibility, while the convenient wheels enable effortless mobility between different spaces. Available in three stylish colors—white, silver, and black—this stand combines functionality with aesthetic appeal, providing a reliable and adaptable solution for your monitor setup.

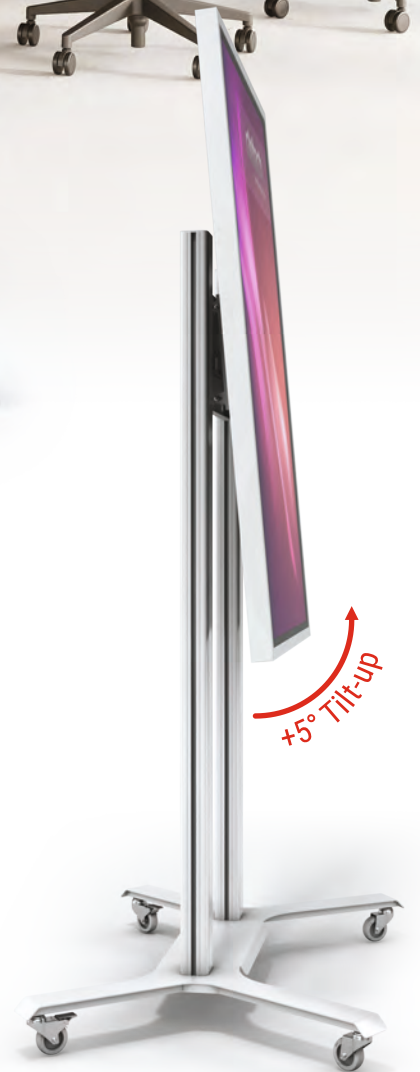

+5° Tilt-up



**ST6MT-F**  
Motorized Single Pole Floor Stand  
from 55" up to 86" with Fix Arms

**SPECIFICATIONS & OPTIONS**

Reference Code	ST6MT-F
Product Code	ST6MT-F-600
Available Screen Size	55" ~ 86"
VESA Pattern	Min 300x300, Max 800x600
Maximum Load	100 kg.
Fix Arms	Yes
Tilt Arms	No
Micro Adjustable Arms	No
Material	Steel, Aluminum, Plastic
Surface Finishing	Electrostatic Powder Coating
Colour Options	Black, Silver, White
Product Dimension	1288x783x1958 mm (WxDxH)
Product Weight	54 kg.
Adjustable Base Feet	Optional
Wheel Kit	WK70 (2 x Brake, 2 x Normal)
Cam Holder	CH02 (Optional)
Shelf	SH05 (Optional)
PDU	PDU3S (Optional)
Remote Control	Yes (wired, detachable)
Height Adjustment	500 mm
Min. Height (Center of Disp.)	1140 mm
Max. Height (Center of Disp.)	1640 mm



The monitor shown is 86".



500 mm  
Height  
Adjustment

Wired Remote Control

**WMT-F**  
Motorized Single Pole Wall Mount  
from 55" up to 86" with Fix Arms

**SPECIFICATIONS & OPTIONS**

Reference Code	WMT-F
Product Code	WMT-F-600
Available Screen Size	55" ~ 86"
VESA Pattern	Min 300x300, Max 800x600
Maximum Load	100 kg.
Fix Arms	Yes
Tilt Arms	No
Micro Adjustable Arms	No
Material	Steel, Aluminum, Plastic
Surface Finishing	Electrostatic Powder Coating
Colour Options	Black, Silver, White
Product Dimension	950x160x1858 mm (WxDxH)
Product Weight	40 kg.
Adjustable Base Feet	Optional
Wheel Kit	No
Cam Holder	CH02 (Optional)
Shelf	SH05 (Optional)
PDU	PDU3S (Optional)
Remote Control	Yes (wired, detachable)
Height Adjustment	500 mm
Min. Height (Center of Disp.)	1040 mm
Max. Height (Center of Disp.)	1540 mm



The monitor shown is 86".

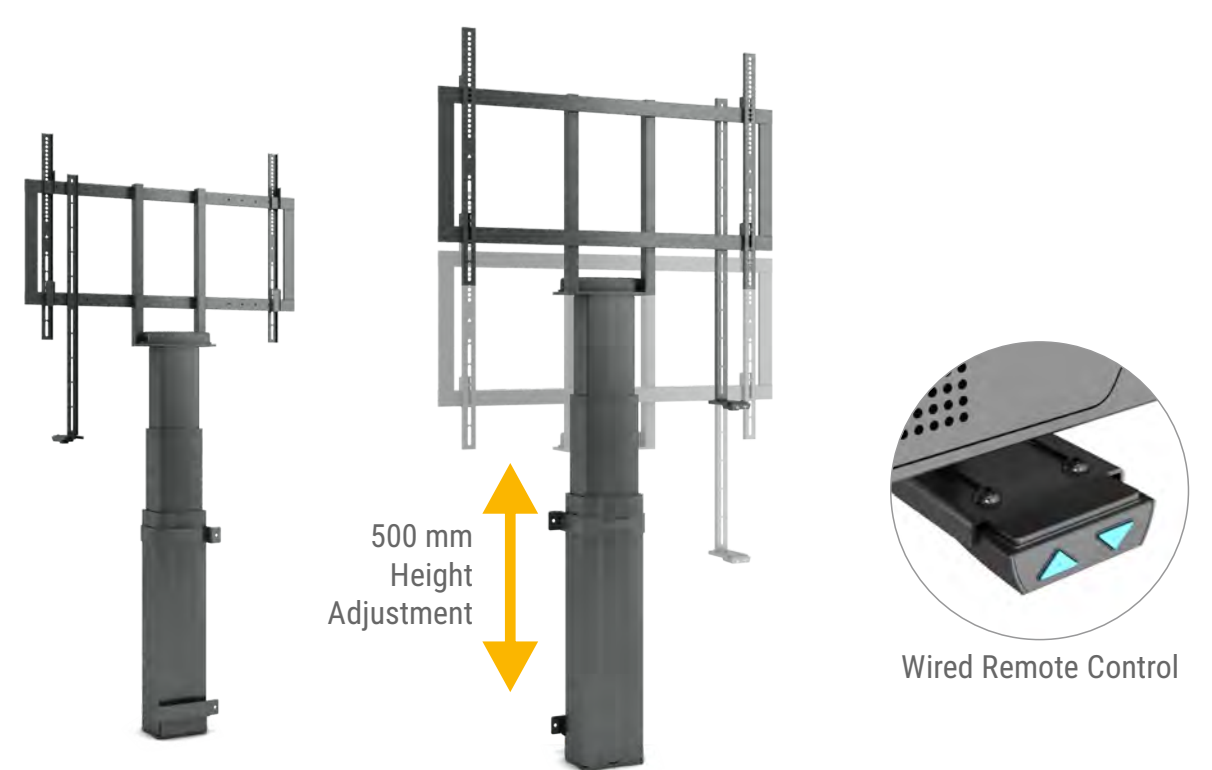

500 mm  
Height  
Adjustment

Wired Remote Control



**FX1L-B**  
Single Light Pole Fix Floor Mount  
from 32" up to 65" with Fix Arms

**SPECIFICATIONS & OPTIONS**

Reference Code	FX1L-B
Product Code	FX1L-B480-LP160-FA300
Available Screen Size	32" ~ 65"
VESA Pattern	Min 100x100, Max 400x300
Maximum Load	40 kg.
Fix Arms	Yes
Tilt Arms	Optional
Micro Adjustable Arms	Optional
Material	Steel, Aluminum, Plastic
Surface Finishing	Electrostatic Powder Coating
Colour Options	Black, Silver, White
Product Dimension	488x191x1612 mm (WxDxH)
Product Weight	11 kg.
Adjustable Base Feet	No
Wheel Kit	No
Cam Holder	CH01 (Optional)
Shelf	SH01 (Optional)
PDU	PDU3S (Optional)



**FX2L-BD**  
Single Light Pole Fix Floor Mount  
from 40" up to 65" with Fix Arms  
Back to Back

**SPECIFICATIONS & OPTIONS**

Reference Code	FX2L-BD
Product Code	FX2L-B480D-LP150D-TA300
Available Screen Size	40" ~ 65"
VESA Pattern	Min 100x100, Max 400x300
Maximum Load	25 kg. per screen
Fix Arms	Optional
Tilt Arms	Yes
Micro Adjustable Arms	Optional
Material	Steel, Aluminum, Plastic
Surface Finishing	Electrostatic Powder Coating
Colour Options	Black, Silver, White
Product Dimension	488x191x1512 mm (WxDxH)
Product Weight	16 kg.
Adjustable Base Feet	No
Wheel Kit	No
Cam Holder	CH01 (Optional)
Shelf	SH03 (Optional)
PDU	PDU3S (Optional)



**FX1S-B**  
Single Strong Pole Fix Floor Mount  
from 40" up to 75" with Fix Arms

**SPECIFICATIONS & OPTIONS**

Reference Code	FX1S-B
Product Code	FX1S-B680-SP180-FA400
Available Screen Size	40" ~ 75"
VESA Pattern	Min 100x100, Max 600x400
Maximum Load	50 kg.
Fix Arms	Yes
Tilt Arms	Optional
Micro Adjustable Arms	Optional
Material	Steel, Aluminum, Plastic
Surface Finishing	Electrostatic Powder Coating
Colour Options	Black, Silver, White
Product Dimension	688x209x1812 mm (WxDxH)
Product Weight	27 kg.
Adjustable Base Feet	No
Wheel Kit	No
Cam Holder	CH01 (Optional)
Shelf	SH01 (Optional)
PDU	PDU3S (Optional)



**FX2S-BD**  
Single Strong Pole Fix Floor Mount  
from 40" up to 75" with Fix Arms  
Back to Back

**SPECIFICATIONS & OPTIONS**

Reference Code	FX2S-BD
Product Code	FX2S-B480D-SP150D-FA400
Available Screen Size	40" ~ 75"
VESA Pattern	Min 100x100, Max 600x400
Maximum Load	30 kg. per screen
Fix Arms	Yes
Tilt Arms	Optional
Micro Adjustable Arms	Optional
Material	Steel, Aluminum, Plastic
Surface Finishing	Electrostatic Powder Coating
Colour Options	Black, Silver, White
Product Dimension	488x229x1512 mm (WxDxH)
Product Weight	28 kg.
Adjustable Base Feet	No
Wheel Kit	No
Cam Holder	CH01 (Optional)
Shelf	SH03 (Optional)
PDU	PDU3S (Optional)





## ST5L

### 3x3 Floor Stand Video Wall Mount

from 46" up to 49" with Pro Arms

#### SPECIFICATIONS & OPTIONS

Reference Code	ST5L
Product Code	ST5L-3340-LP250-PRO400
Available Screen Size	46" ~ 49"
VESA Pattern	Min 100x100, Max 600x400
Maximum Load	25 kg. per screen
Fix Arms	No
Tilt Arms	No
Micro Adjustable Arms	Yes
Material	Steel, Aluminum, Plastic
Surface Finishing	Electrostatic Powder Coating
Colour Options	Black, Silver, White
Product Dimension	2708x900x2561 mm (WxDxH)
Product Weight	80 kg.
Adjustable Base Feet	Standard
Wheel Kit	WK50 (Optional)
Cam Holder	CH01 (Optional)
Shelf	SH03 (Optional)
PDU	PDU3S, PDU8S (Optional)



## FX2S

### Fixed Floor Mount Video Wall

from 46" up to 49" with Pro Arms

#### SPECIFICATIONS & OPTIONS

Reference Code	FX2S
Product Code	FX2S-2240D-LP180-PRO400
Available Screen Size	46" ~ 49"
VESA Pattern	Min 100x100, Max 600x400
Maximum Load	30 kg. per screen
Fix Arms	No
Tilt Arms	No
Micro Adjustable Arms	Yes
Material	Steel, Aluminum, Plastic
Surface Finishing	Electrostatic Powder Coating
Colour Options	Black, Silver, White
Product Dimension	1908x360x1866 mm (WxDxH)
Product Weight	80 kg.
Adjustable Base Feet	No
Wheel Kit	No
Cam Holder	CH01 (Optional)
Shelf	SH03 (Optional)
PDU	PDU3S, PDU8S (Optional)

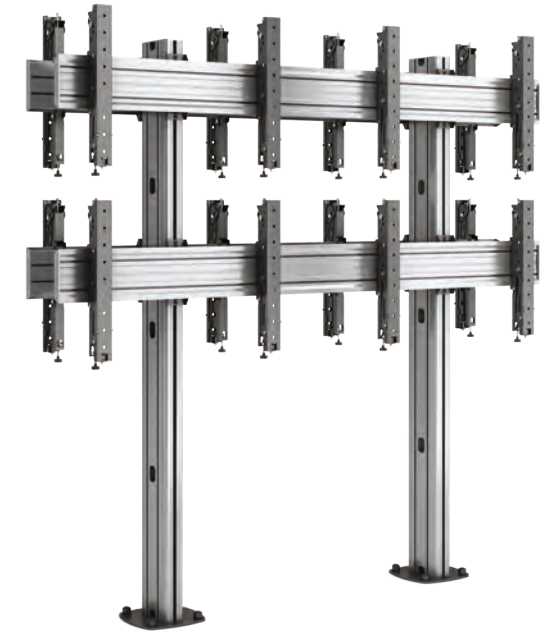

## ST5LM

### 2x2 Mobile Stand Video Wall Mount

from 46" up to 49" with Pro Arms

#### SPECIFICATIONS & OPTIONS

Reference Code	ST5LM
Product Code	ST5LM-2240-LP180-PRO400
Available Screen Size	46" ~ 49"
VESA Pattern	Min 100x100, Max 600x400
Maximum Load	25 kg. per screen
Fix Arms	No
Tilt Arms	No
Micro Adjustable Arms	Yes
Material	Steel, Aluminum, Plastic
Surface Finishing	Electrostatic Powder Coating
Colour Options	Black, Silver, White
Product Dimension	1908x900x1934 mm (WxDxH)
Product Weight	68 kg.
Adjustable Base Feet	Bf50 (Optional)
Wheel Kit	Yes
Cam Holder	CH01 (Optional)
Shelf	SH03 (Optional)
PDU	PDU3S, PDU8S (Optional)





## FX2CL

2x1 Ceiling Mount Menuboard  
from 40" up to 55" with Tilt Arms

### SPECIFICATIONS & OPTIONS

Reference Code	FX2CL
Product Code	FX2CL-2140-LP110-TA300
Available Screen Size	40" ~ 55"
VESA Pattern	Min 100x100, Max 400x300
Maximum Load	25 kg. per screen
Fix Arms	Optional
Tilt Arms	Yes
Micro Adjustable Arms	Optional
Material	Steel, Aluminum, Plastic
Surface Finishing	Electrostatic Powder Coating
Colour Options	Black, Silver, White
Product Dimension	1908x353x1167 mm (WxDxH)
Product Weight	23 kg.
Adjustable Base Feet	No
Wheel Kit	No
Cam Holder	CH01 (Optional)
Shelf	SH01 (Optional)
PDU	PDU3S, PDU8S (Optional)



## WM-2140

2x1 Wall Mount Menuboard  
from 40" up to 55" with Tilt Arms

### SPECIFICATIONS & OPTIONS

Reference Code	WM-2140
Product Code	WM-2140-TA400
Available Screen Size	40" ~ 55"
VESA Pattern	Min 100x100, Max 400x300
Maximum Load	25 kg. per screen
Fix Arms	Optional
Tilt Arms	Yes
Micro Adjustable Arms	Optional
Material	Steel, Aluminum, Plastic
Surface Finishing	Electrostatic Powder Coating
Colour Options	Black, Silver, White
Product Dimension	1908x126x430 mm (WxDxH)
Product Weight	16 kg.
Adjustable Base Feet	No
Wheel Kit	No
Cam Holder	CH01 (Optional)
Shelf	No
PDU	PDU3S, PDU8S (Optional)



## FX2CL

2x2 Ceiling Mount Video Wall  
from 46" up to 49" with Pro Arms

### SPECIFICATIONS & OPTIONS

Reference Code	FX2CL
Product Code	FX2CL-2240-LP180-PRO400
Available Screen Size	46" ~ 49"
VESA Pattern	Min 100x100, Max 600x400
Maximum Load	25 kg. per screen
Fix Arms	No
Tilt Arms	No
Micro Adjustable Arms	Yes
Material	Steel, Aluminum, Plastic
Surface Finishing	Electrostatic Powder Coating
Colour Options	Black, Silver, White
Product Dimension	1908x190x1892 mm (WxDxH)
Product Weight	68 kg.
Adjustable Base Feet	No
Wheel Kit	No
Cam Holder	CH01 (Optional)
Shelf	SH01 (Optional)
PDU	PDU3S, PDU8S (Optional)



## WM-2240

2x2 Video Wall Mount  
from 46" up to 49" with Tilt Arms

### SPECIFICATIONS & OPTIONS

Reference Code	WM-2240
Product Code	WM-2240-PRO400
Available Screen Size	46" ~ 49"
VESA Pattern	Min 100x100, Max 600x400
Maximum Load	25 kg. per screen
Fix Arms	No
Tilt Arms	No
Micro Adjustable Arms	Yes
Material	Steel, Aluminum, Plastic
Surface Finishing	Electrostatic Powder Coating
Colour Options	Black, Silver, White
Product Dimension	1908x126x1200 mm (WxDxH)
Product Weight	46 kg.
Adjustable Base Feet	No
Wheel Kit	No
Cam Holder	CH01 (Optional)
Shelf	No
PDU	PDU3S, PDU8S (Optional)





ARMS

Fixed, Tilt, Micro Adjustment, Pop-up

TILT ARMS

-6° ~ +12°



TA300 VESA 300    TA400 VESA 400    TA600 VESA 600    TA900 VESA 900

FIX ARMS

from VESA 100 up to 900

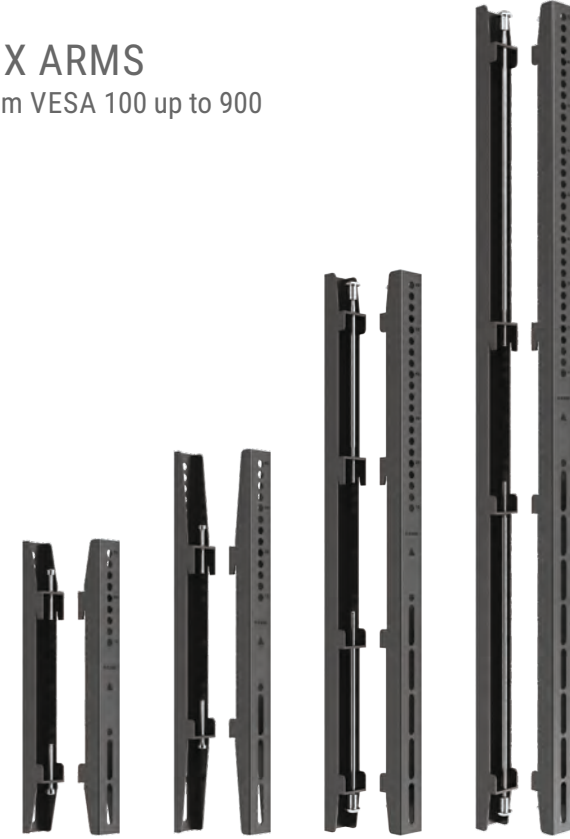

FA300 VESA 300    FA400 VESA 400    FA600 VESA 600    FA900 VESA 900

PRO ARMS

Micro Adjustment



POP-UP ARMS

Micro Adjustment & Push out

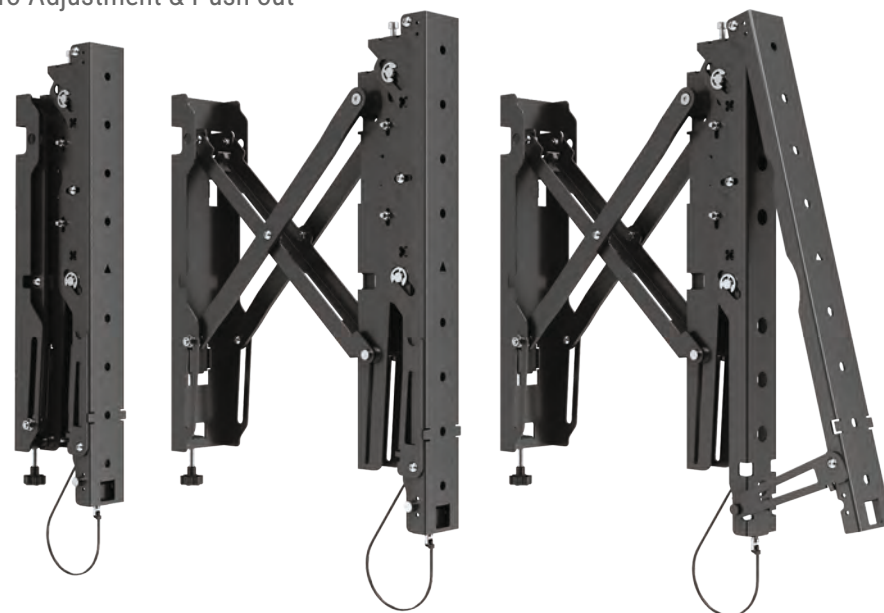

PROFILES

Poles & Bars

BARS

Horizontal Mounting Rail



LIGHT POLE

Vertical Column with Cable Management

STRONG POLE

Vertical Column with Cable Management



CONNECTORS

Poles, Bars, Wall



SPCP  
Strong Pole  
Connecting Part

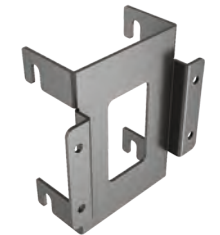

LPCP  
Light Pole  
Connecting Part



BRCP  
Horizontal Rail  
Connecting Part



WCP  
Wall Mount  
Connecting Part

ACCESSORIES

Wheels, Feet



WK75  
Wheel Diameter  
75 mm

WK50  
Wheel Diameter  
50 mm



BF40  
Adjustable Feet  
Diameter 40 mm

BF50  
Adjustable Feet  
Diameter 50 mm



BASES

Fixed, Stand Floor, Trolley



**FX1L**  
Fix Base for  
Light Pole



**FX2L / FX2CL**  
Fix & Ceiling Base  
for Light Pole



**FX1S**  
Fix Base for  
Strong Pole

**FX2S / FX2CS**  
Fix & Ceiling Base  
for Strong Pole



**ST1L**  
Floor Stand  
for Light Pole



**ST2L**  
Trolley for  
Light Pole



**ST1S**  
Floor Stand  
for Strong Pole



**ST2LD**  
Trolley for  
Double Light Pole



**ST1LD**  
Floor Stand for  
Double Light Pole



**ST2S**  
Trolley for  
Strong Pole



**ST3L**  
Trolley for  
Light Pole



**ST3LD**  
Trolley for  
Double  
Light Pole



**ST3S**  
Trolley for  
Strong Pole



**ST5L**  
Floor Stand  
for Light Pole



**ST5LM**  
Trolley  
for Light Pole

ACCESSORIES

Cam Holder, Shelves

**CH01**  
Cam Holder for  
Horizontal Bar

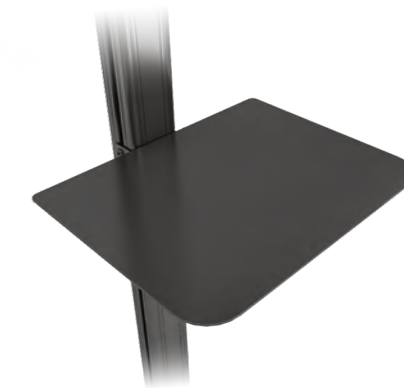

**SH01**  
Shelf for  
Light Pole

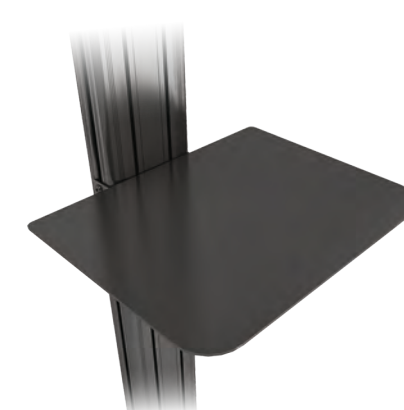

**SH02**  
Shelf for  
Strong Pole



Notes

